

### Trademarks

Autel®, MaxiSys®, and MaxiDAS® are trademarks of Autel Intelligent Technology Corp., Ltd., registered in China, the United States and other countries. All other marks are trademarks or registered trademarks of their respective holders.

### Copyright Information

No part of this manual may be reproduced, stored in a retrieval system or transmitted, in any form or by any means, electronic, mechanical, photocopying, recording, or otherwise, without the prior written permission of Autel.

### Disclaimer of Warranties and Limitation of Liabilities

All information, specifications and illustrations in this manual are based on the latest information available at the time of printing. Autel reserves the right to make changes at any time without notice.

### For Services and Support:

	pro.autel.com / www.autel.com
	1-855-288-3587/1-855-AUTELUS (North America) 86-755-86147779 (China)
	Support@autel.com

For technical assistance in all other markets, please contact your selling agent.

### Safety Information

For your own safety and the safety of others, and to prevent damage to the equipment and vehicles upon which it is used, it is important that the safety instructions presented throughout this manual be read and understood by all persons operating or coming into contact with the equipment.

There are various procedures, techniques, tools, and parts for servicing vehicles, as well as in the skill of the individual doing the work. Because of the vast number of test applications and variations in the products that can be tested with this instrument, we cannot possibly anticipate or provide advice or safety messages to cover every situation.

It is the automotive technician's responsibility to be knowledgeable of the system being tested. It is essential to use proper service methods and test procedures. It is important to perform tests in an appropriate and acceptable manner that does not endanger your safety, the safety of others in the work area, the equipment being used, or the vehicle being tested.

Before using the equipment, always refer to and follow the safety messages and applicable test procedures provided by the manufacturer of the vehicle or equipment being tested. Use the equipment only as described in this manual. Read, understand, and follow all safety messages and instructions in this manual.

### Safety Messages

Safety messages are provided to help prevent personal injury and equipment damage. All safety messages are introduced by a signal word indicating the hazard level.

 **DANGER:** Indicates an imminently hazardous situation which, if not avoided, will result in death or serious injury to the operator or to bystanders.

 **WARNING:** Indicates a potentially hazardous situation which, if not avoided, could result in death or serious injury to the operator or to bystanders.

### Safety Instructions

The safety messages herein cover situations Autel is aware of. Autel cannot know, evaluate or advise you as to all of the possible hazards. You must be certain that any condition or service procedure encountered does not jeopardize your personal safety.

 **DANGER:** When an engine is operating, keep the service area WELL VENTILATED or attach a building exhaust removal system to the engine exhaust system. Engines produce carbon monoxide, an odorless, poisonous gas that causes slower reaction time and can lead to serious personal injury or loss of life.

### WARNINGS:

- Always perform automotive testing in a safe environment.
- Wear safety eye protection that meets ANSI standards.
- Keep clothing, hair, hands, tools, test equipment, etc. away from all moving or hot engine parts.
- Operate the vehicle in a well ventilated work area, for exhaust gases are poisonous.
- Put the transmission in PARK (for automatic transmission) or NEUTRAL (for manual transmission) and make sure the parking brake is engaged.
- Put blocks in front of the drive wheels and never leave the vehicle unattended while testing.
- Be extra cautious when working around the ignition coil, distributor cap, ignition wires and spark plugs. These components create hazardous voltages when the engine is running.
- Keep a fire extinguisher suitable for gasoline, chemical, and electrical fires nearby.
- Do not connect or disconnect any test equipment while the ignition is on or the engine is running.
- Keep the test equipment dry, clean, free from oil, water or grease. Use a mild detergent in a clean cloth to clean the outside of the equipment as necessary.
- Do not drive the vehicle and operate the test equipment at the same time. Any distraction may cause an accident.
- Refer to the service manual for the vehicle being serviced and adhere to all diagnostic procedures and precautions. Failure to do so may result in personal injury or damage to the test equipment.
- To avoid damaging the test equipment or generating false data, make sure the vehicle battery is fully charged and the connection to the vehicle DLC is clean and secure.
- Do not place the test equipment on the distributor of the vehicle. Strong electro-magnetic interference can damage the equipment.

# MAXISYS DISPLAY TABLET

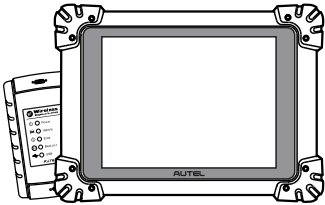

MaxiSys MS908S II

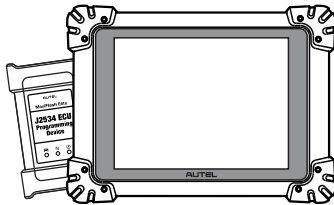

MaxiSys MS908S Pro II

*Thank you for purchasing MaxiSys MS908S II/ MaxiSys MS908S Pro II. This tool is manufactured to a high standard and will provide years of trouble-free performance when used in accordance to these instructions and properly maintained.*

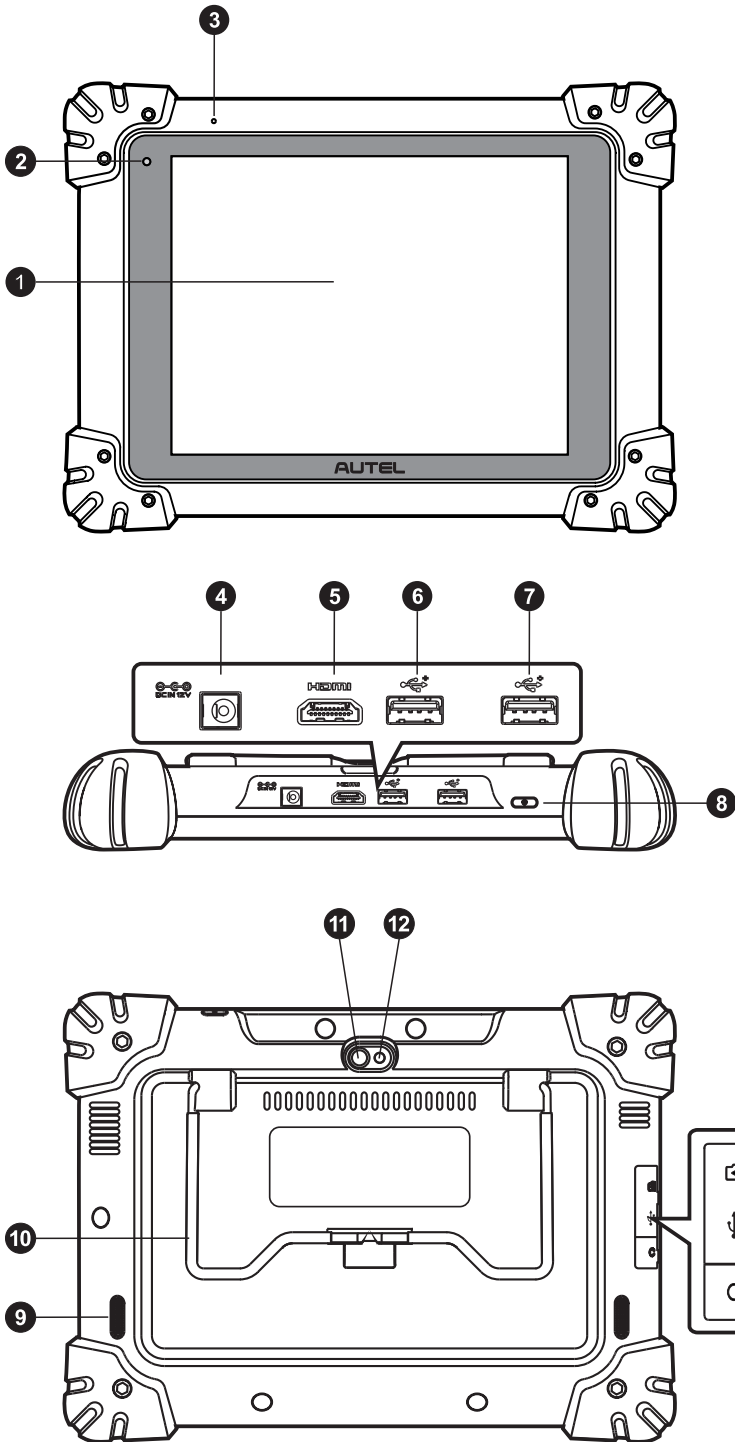

## PRODUCT DESCRIPTIONS

The MaxiSys Diagnostic Platform is an evolutionary smart solution for specialized automotive diagnosis. Utilizing the powerful octa-core processor (Qualcomm Kryo 260 CPU) and a 9.7-inch LED capacitive touch screen, combined with the best possible coverage of OE-level diagnostics, and based on the revolutionary multitask-capable Android Operating System, the MaxiSys organizes information with test instrumentation to help you diagnose symptoms, codes, and customer complaints easily, quickly and efficiently.

The MaxiSys system has two main components:

- MaxiSys Display Tablet — the central processor and monitor for the system.
- Vehicle Communication Interface (VCI) — the device for accessing vehicle data.

**NOTE:** Autel provides two optional VCI devices for your choice. One is the J2534 Programming Device; the other is the Bluetooth Diagnostic Interface. Both will be introduced in this manual.

1. 9.7" LED Capacitive Touch Screen
2. Ambient Light Sensor — detects ambient brightness
3. Microphone
4. DC Power Supply Input Port
5. HDMI Port
6. USB Port
7. USB Port
8. Lock/Power Button — turns the MaxiSys tool on and off (long press), or locks the screen (short press)
9. Audio Speaker
10. Collapsible Stand — extends from the back to allow hands-free viewing of the display tablet at a 30° angle.
11. Camera Lens
12. Camera Flash
13. Mini SD Card Slot — optional module
14. Mini USB Port
15. Head Phone Jack

# VEHICLE COMMUNICATION INTERFACE (VCI)

## 1. Wireless Bluetooth Diagnostic Interface

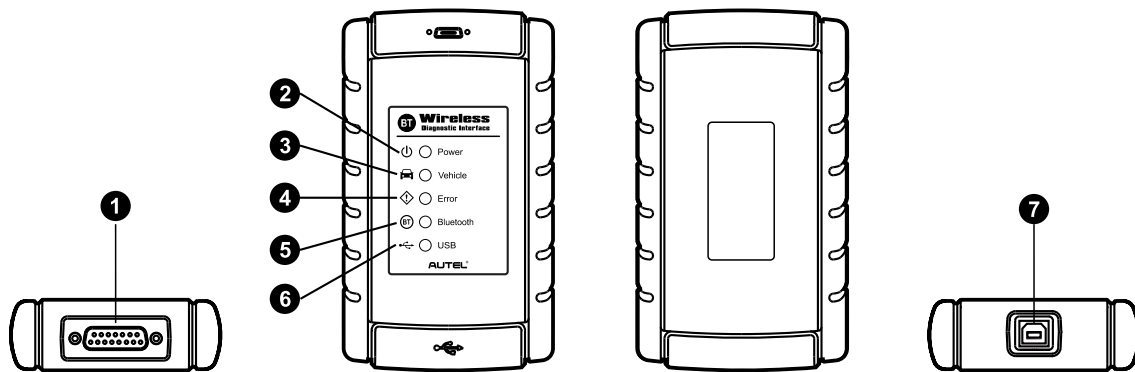

Comes with MaxiSys MS908S II Tool Kit

1. Vehicle Data Connector (DB15-Pin)
2. Power LED — lights solid green when the device is powered on.
3. Vehicle LED — blinks green when the device is communicating with the vehicle's network.
4. Error LED — lights solid red when a serious hardware failure occurs; also blinks red when the device is updating software/firmware.
5. Bluetooth LED — lights solid green when the device is connected with the MaxiSys tablet through wireless Bluetooth communication; also blinks green when the data is being transmitted between the vehicle and the tablet.
6. USB LED — lights solid green when the device is properly connected and communicating with the MaxiSys display tablet via the USB cable.
7. USB Port

## 2. J2534 ECU Programming Device

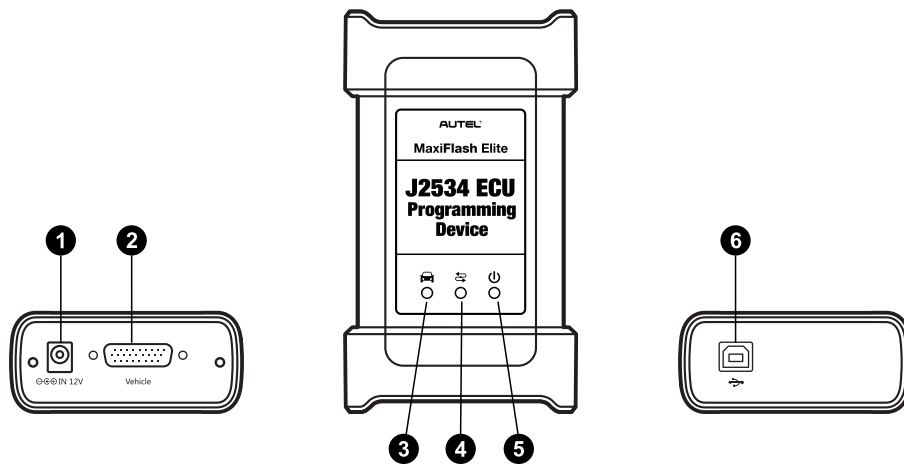

Comes with MaxiSys MS908S Pro II Tool Kit

1. DC Power Supply Input Port
2. Vehicle Data Connector (DB26-Pin)
3. Vehicle LED — blinks green when the device is communicating with the vehicle's system.
4. Connection LED — lights solid green when the device is properly connected with the tablet via the USB cable or lights solid blue via wireless Bluetooth connection.
5. Power LED — lights solid green when the device is powered on.
6. USB Port

**! IMPORTANT:** Do not disconnect the programming device while the vehicle LED is on! If the flash programming procedure is interrupted while the vehicle's ECU is blank or only partially programmed, the module may be unrecoverable.

# GETTING STARTED



**IMPORTANT:** Before operating or maintaining this unit, please read these instructions carefully, paying extra attention to the safety warnings and precautions. Use this unit correctly and with care. Failure to do so may cause damage and/or personal injury and will void the product warranty.

**1** Connect the main cable's female adapter to the Vehicle Data Connector on the VCI unit, and tighten the captive screws.

**A: For Wireless Bluetooth Diagnostic Interface**

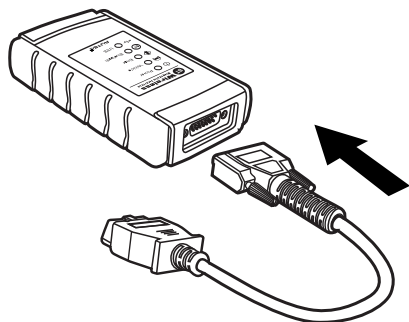

**B: For J2534 ECU Programming Device**

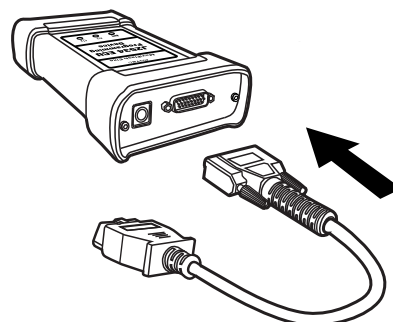

**2** Connect the cable's 16-pin male adapter to the vehicle's DLC, which is generally located under the vehicle dash.

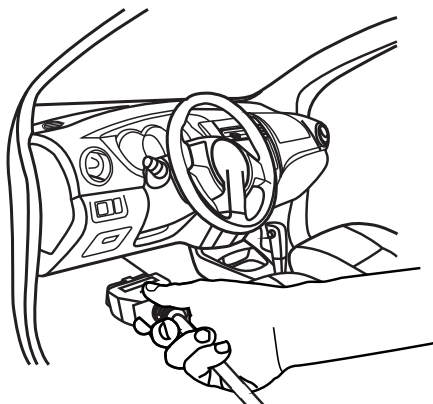

**3** Power up the MaxiSys tablet, make sure the tablet has a charged battery or is connected to the supplied DC power supply.

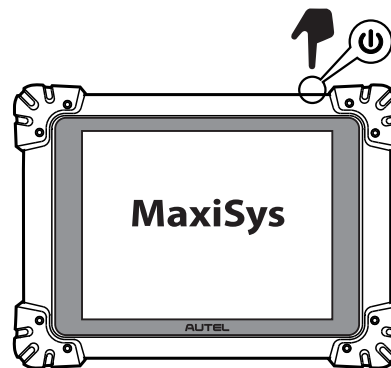

**4** Pair the tablet with the VCI device via Bluetooth to establish a communication link.

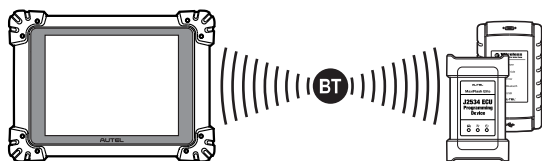

**NOTE:** The MaxiSys tablet and the VCI device are configured to automatically synchronize with each other when you first use them, so there is no need to perform any pairing procedure.

**5** When the VCI device is properly connected to the vehicle and the MaxiSys tablet, the VCI status button at the bottom bar on the display screen shows a green BT badge at the corner, indicating the platform is ready to start vehicle diagnosis.

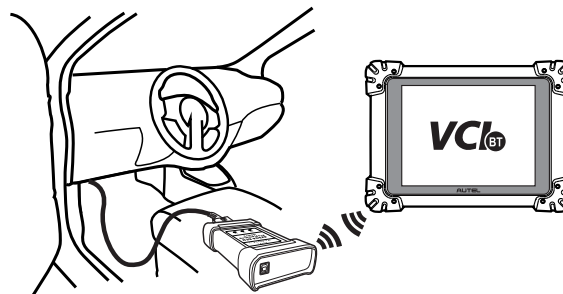

Your MaxiSys MS908S II/MaxiSys MS908S Pro II is now ready for use.

图号

REV	POSITION	DATE	DESCRIPTION

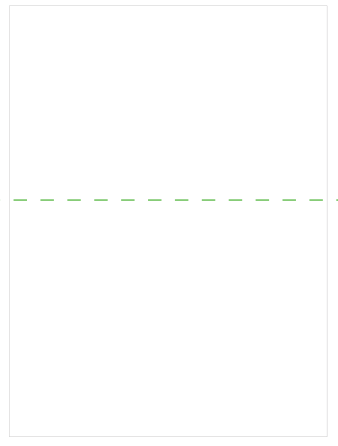

折页沿中线再对折线

折页对折线，按PDF文档页面顺序依次排

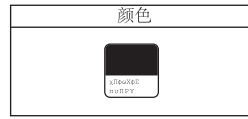

RELEASE LEVEL: &PROJ\_RELEASE  
FILENAME: MODEL NAME

DIM			SHEETMETAL		MACHINING		AUTEL 道通科技股份有限公司 Autel Intelligent Technology Corp.Ltd.		TITLE: 快速指引		
0-6	0.10	0.05	These Drawings And Specification Are The Property Of AUTEL And Shall NOT Be Reproduced Copied Or Used In Any Manner Without The Prior Written Consent Of AUTEL.		DRAW: 张贝贝		UNITS: 210x285 mm	DWGNO: AUT62060694		PART NO: 500006161	
6-30	0.15	0.10	PROJ		CHKD: 兰金香		FINISH:		REV		
30-120	0.25	0.15			STAD:		MASS(Kg):		REVISION		
120-300	0.35	0.20	APPD: 廖岳龙		SCALE:		PRODUCT: MS908S II&Pro		Material: 120g书纸		
300-600	0.50	0.25	SHEET: 1 OF 1		PROJECT: MS908S II&Pro		DATE:		DRAWN BY:		
600-1200	0.60	0.30	PROJECT: MS908S II&Pro		DATE:		DATE:		DATE:		
>1200	0.80	0.50	PROJECT: MS908S II&Pro		DATE:		DATE:		DATE:		
ANG.	1~	30°	PROJECT: MS908S II&Pro		DATE:		DATE:		DATE:		