

[Back to Main Page](#)

Julie - Universal Car Emulator Programs:

Seat occupancy sensor programs

BMW.....	4
FIAT.....	7
FORD.....	9
MAZDA.....	11
MERCEDES.....	13
MINI	22
OPEL.....	24

Wiring colour codes

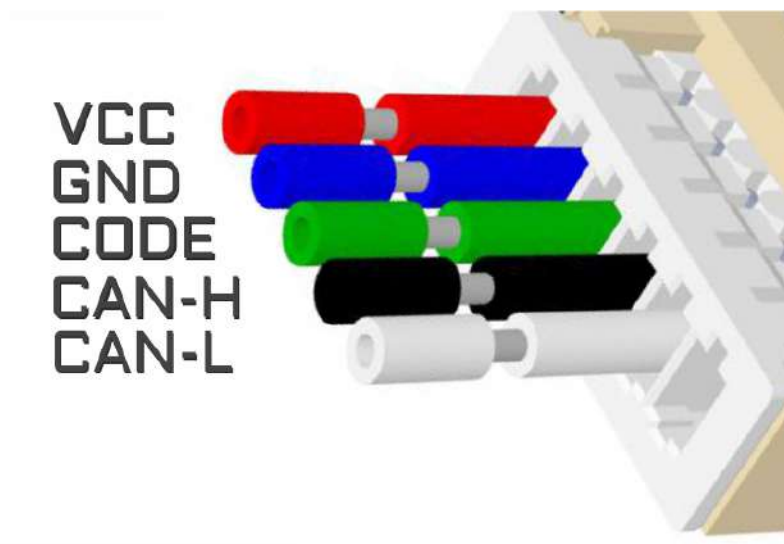

The LED behavior

- no jumpers – diagnostic mode - it flashes every second
 - adjusting to the ECU – flashing 0,1 sec
- after adjusting it lights constantly and blinks every other second

[Back to Main Page](#)

ATTENTION!!!

This emulator can only be used for testing purposes or to verify accurate functioning of the AirBag system.

This emulator cannot remain in your car as a replacement for new seat occupancy mat

The emulator needs to be connected to the plug under the passenger seat instead of original seat occupancy sensor.

There are 3 cables

+12V ACC **red**

GND **blue**

Digital signal **green**

Before connecting the emulator, use multimeter to check signals on pins in the plug!

[Back to Main Page](#)

BMW

No.	Model	Year	Solder jumpers	
1	BMW Series 1 – E81	2007-2010	1+7	OPEN
	BMW Series 3 – E90, E92, E93			
	BMW Series 5 – E60, E63, E64			
	BMW Series 7 – E65			
	BMW Series X – E70, E71			
2	BMW Series 1 – E87	2003-2007	4+7	OPEN
	BMW Series 3 – E90			
	BMW Series 5 – E60, E63			
	BMW Series 7 - E65			
	BMW Series 3 – E36, E46	1997-2003		
	BMW Series 5 – E39			
	BMW Series 7 – E38			
	BMW Series 8 – E31			
	BMW Series X – E53			
3	BMW Series 1 – E87	2003-2007	Child seat installed 1+4+7	OPEN
	BMW Series 3 – E90			
	BMW Series 5 – E60, E63			
	BMW Series 7 - E65			
	BMW Series 3 – E36, E46	1997-2003		
	BMW Series 5 – E39			
	BMW Series 7 – E38			
	BMW Series 8 – E31			
	BMW Series X – E53			

[Back to Main Page](#)

No.1 BMW

USE

European models

(2007 – 2010)

BMW Series 1 – E81

BMW Series 3 – E90, E92, E93

BMW Series 5 – E60, E63, E64

BMW Series 7 – E65

BMW Series X – E70, E71



**In Universal Julie Emulator
solder jumpers**

1 + 7



Attention!

If still after installation of the emulator your car signals unfastened passanger seatbelt fault, put a resitor in place of the seatbelt sensor.

For E90, use 680-Ohm resistor

For E60, use 510-Ohm resistor

Back to Main Page

No.2 BMW

USE

(2003 – 2007)

BMW Series 1 – E87

BMW Series 3 – E90

BMW Series 5 – E60, E63

BMW Series 7 - E65

(1997 – 2003)

BMW Series 3 – E36, E46

BMW Series 5 – E39

BMW Series 7 – E38

BMW Series 8 – E31

BMW Series X – E53



**In Universal Julie Emulator
solder jumpers
4 + 7**



Insert a 510-ohm resistor into the seat belt socket

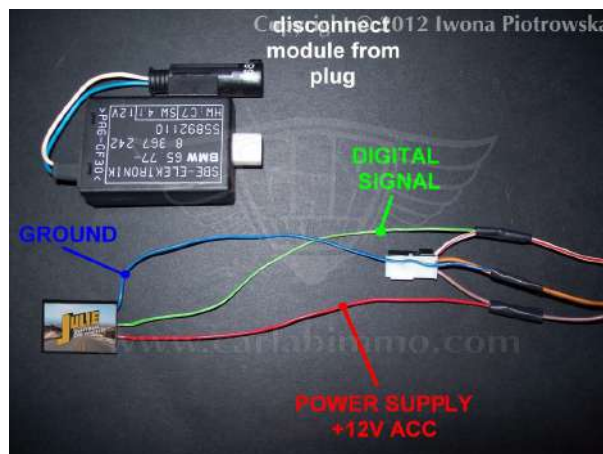

Back to Main Page

No.3 BMW

USE

(2003 – 2007)

BMW Series 1 – E87

BMW Series 3 – E90

BMW Series 5 – E60, E63

BMW Series 7 - E65

(1997 – 2003)

BMW Series 3 – E36, E46

BMW Series 5 – E39

BMW Series 7 – E38

BMW Series 8 – E31

BMW Series X – E53



In Universal Julie Emulator
solder jumpers
1+4+7



Insert a 510-ohm resistor into the seat belt socket

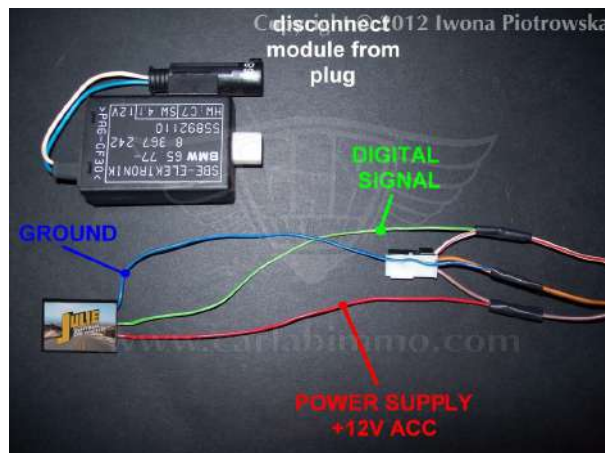

[Back to Main Page](#)

FIAT

No.	Model	Solder jumpers	
1	Fiat Stilo	2+ 3+4+7	OPEN
2	Fiat Stilo	Child seat installed: 1+2+3+4+7	OPEN

[Back to Main Page](#)

No.1 FIAT STILO

USE

Fiat Stilo



In Universal Julie Emulator
solder jumpers
2+3+4+7

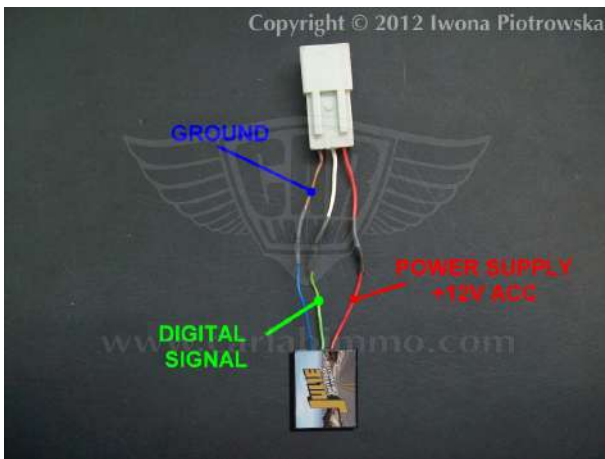

[Back to Main Page](#)

No.2 FIAT STILO

USE

Fiat Stilo



In Universal Julie Emulator
solder jumpers
1+2+3+4+7

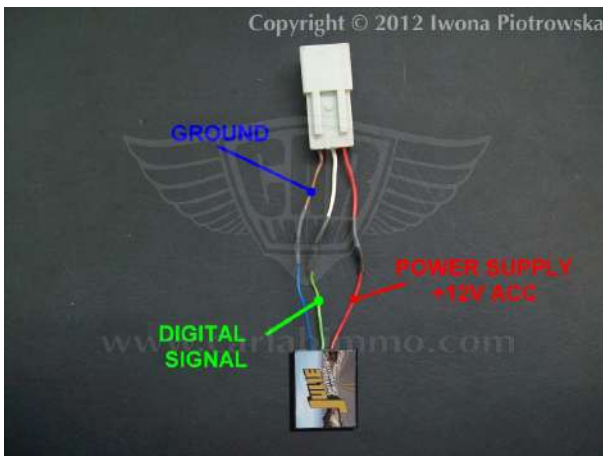

[Back to Main Page](#)

FORD

No	Model	Year	Solder jumpers	
1	Ford Mondeo	2001-2003	1+3+5+7	OPEN

Back to Main Page

No.1 FORD

USE

(2001-2003)
Ford Mondeo



In Universal Julie Emulator
solder jumpers
1+3+5+7

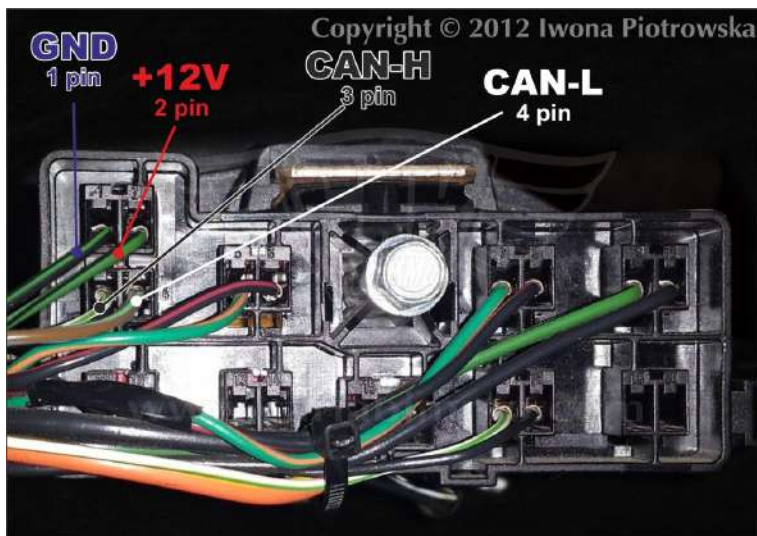

Connection diagram example

[Back to Main Page](#)

MAZDA

No.	Model	Solder jumpers	
1	Mazda Premacy, MX-5, 626, 323, 6 GG/GY	3+4+7	OPEN
2	Mazda Premacy, MX-5, 626, 323, 6 GG/GY	Child seat installed: 1+3+4+7	OPEN

Back to Main Page

No.1 MAZDA

USE

- Mazda Premacy
- Mazda MX-5
- Mazda 626
- Mazda 323
- Mazda 6 GG/GY



In Universal Julie Emulator
solder jumpers
3+4+7

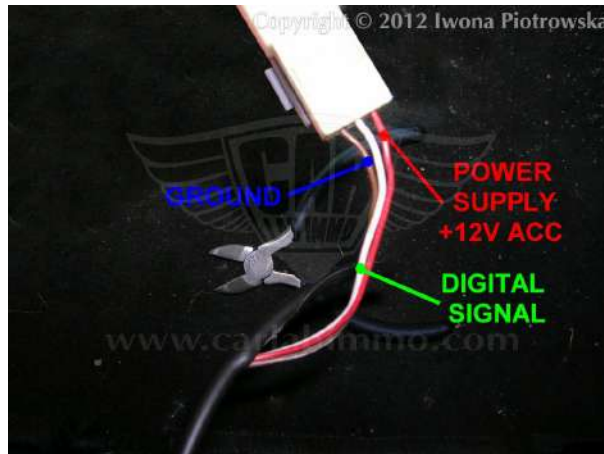

Back to Main Page

No.2 MAZDA

USE

Mazda Premacy

Mazda MX-5

Mazda 626

Mazda 323

Mazda 6 I



In Universal Julie Emulator
solder jumpers

1+3+4+7

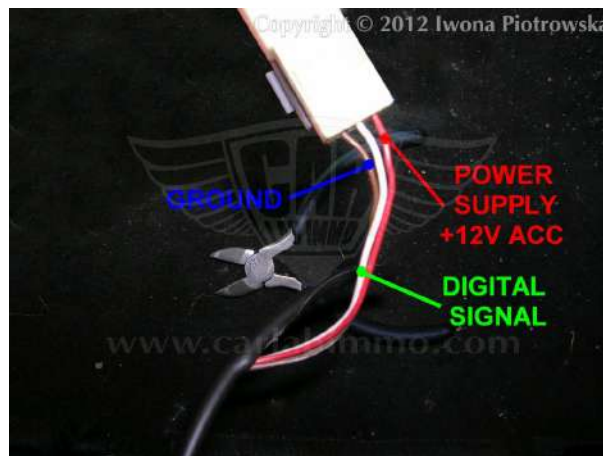

[Back to Main Page](#)

MERCEDES

No.	Model	Year	Solder jumpers	
1	Mercedes E-class W211 (Temic Armada controller)	2004-2007	1+5+7	OPEN
	Mercedes E-class W211 (Bosch controller)	2002-2007		
	Mercedes C-class W203	2006-2007		
	Mercedes CLS-class W219	2005-2010		
	Mercedes CLK-class W209	2006-2009		
	Mercedes S-class W220	2002-2005		
	Mercedes S-class W221	2006		
2	Mercedes E-class W211 (Temic controller)	2004-2007	5+7	OPEN
	Mercedes SL-class W230	2004		
	Mercedes SLK-class W171	2004-2011		
3	Mercedes E-class W211 (Temic Armada controller)	2002-2003	1+4+6+7	OPEN
4	Mercedes E-class W211 with: <i>Temic controller no. 002 820 35 26</i> <i>Bosch controller no. 002 820 29 26; 0 285 001 441</i>	2002-2003	2+5+7	OPEN
5	Mercedes E-class W211 (Temic controller)	2002-2004	2+7	OPEN
	Mercedes S-class W220	2003-2005		
6	Mercedes E-class W210 (with airbag OFF indicator after lifting)	1999-2003	2+3+7	OPEN
	Mercedes Vito II W639	2002-2005		
	Mercedes ML-class W163	2000-		
	Mercedes A-class W168	2002-2005		
	Mercedes S-class W220	2002-2003		
	Mercedes C-class W203	-2005		
	Mercedes CLK-class W209	2002-		
	Mercedes Vaneo W414			

[Back to Main Page](#)

7	Mercedes A-class W168	1997-2001	3+7	OPEN
	Mercedes C-class W202	1999-2001		
	Mercedes Vito W638	-2003		
	Mercedes ML-class W163 (TRW controller)	1999		
	Mercedes E-class W210 (before lifting – with airbag OFF indicator)	-1999		
8	Mercedes E-Class W212	2009-2016	2+3+4+6+7	OPEN
	Mercedes E-Class S212/C207/A207	2013-2016		
9	Mercedes E-class W211 (Temic controller)	2002-2004	Child seat installed: 1+2+7	OPEN
	Mercedes S-class W220	2003-2005		
10	Mercedes E-class W210 (with airbag OFF indicator after lifting)	1999-2003	Child seat installed: 1+2+3+7	OPEN
	Mercedes Vito II W639	2002-2005		
	Mercedes ML-class W163	2000-		
	Mercedes A-class W168	2002-2005		
	Mercedes S-class W220	2002-2003		
	Mercedes C-class W203	-2005		
	Mercedes CLK-class W209	2002-		
Mercedes Vaneo W414				
11	Mercedes A-class W168	1997-2001	Child seat installed: 1+3+7	OPEN
	Mercedes C-class W202	1999-2001		
	Mercedes Vito W638	-2003		
	Mercedes ML-class W163 (TRW controller)	1999		
	Mercedes E-class W210 (before lifting – with airbag OFF indicator)	-1999		

[Back to Main Page](#)

No.1 Mercedes

USE

Mercedes E-Class W211 with Temic Armada controller (2004-2007)

Mercedes E-Class W211 with Bosch controller (2002-2007)

Mercedes C-Class W203 (2006-2007)

Mercedes CLS-Class W219 (2005-2010)

Mercedes CLK-Class W209 (2006-2009)

Mercedes S-Class W220 (2002-2005)

Mercedes S-Class W221 (2006)



**In Universal Julie Emulator
solder jumpers**

1+5+7



Insert a 100-ohm resistor into the seat belt socket

[Back to Main Page](#)

No.2 Mercedes

USE

Mercedes E-Class W211 with Temic controller (2004-2007)

Mercedes SL-Class W230 (2004)

Mercedes SLK-Class W171 (2004-2011)



**In Universal Julie Emulator
solder jumpers**

5+7



Insert a 100-ohm resistor into the seat belt socket

[Back to Main Page](#)

No.3 Mercedes

USE

Mercedes E-Class W211 with Temic Armada controller (2002-2003)



In Universal Julie Emulator
solder jumpers

1+4+6+7



Insert a 100-ohm resistor into the seat belt socket

[Back to Main Page](#)

No.4 Mercedes

USE

Mercedes E-Class W211 (2002-2003)
with the following airbag control units:

—

Temic 002 820 35 26

Bosch 002 820 29 26; 0 285 001 441



**In Universal Julie Emulator
solder jumpers
2+5+7**



Insert a 100-ohm resistor into the seat belt socket

Back to Main Page

No.5 Mercedes

USE

Mercedes E-Class W211 with Temic controller (2002-2004)

Mercedes S-Class W220 (2003-2005)



In Universal Julie Emulator
solder jumpers
2+7



Insert a 100-ohm resistor into the seat belt socket

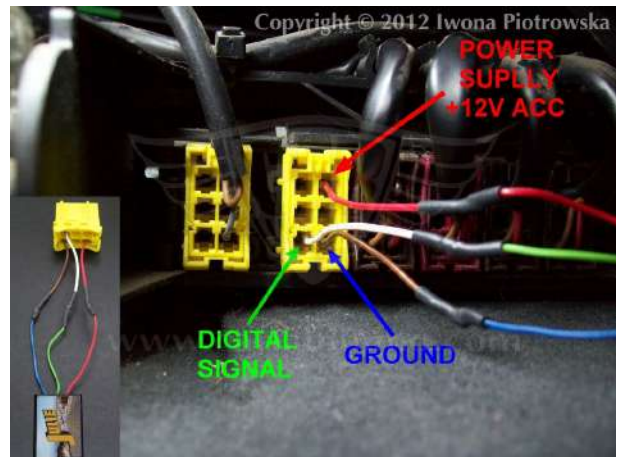
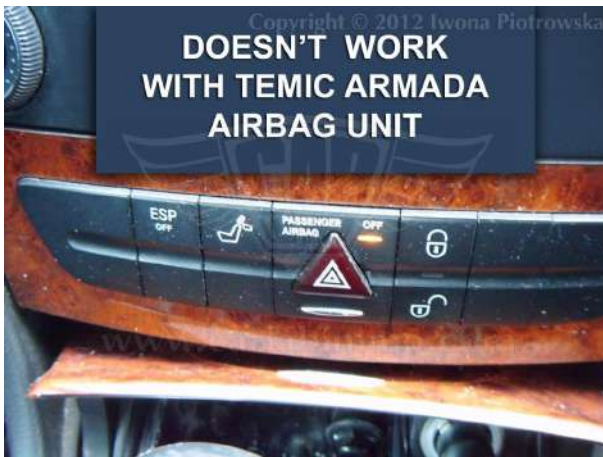

[Back to Main Page](#)

No.6 Mercedes

USE

- Mercedes** E-Class W210 after lifting-
-with airbag OFF indicator(1999-2003)
- Mercedes** Vito II W639 (2002-2005)
- Mercedes** ML-Class W163 (2000-)
- Mercedes** A-Class W168 (2002-2005)
- Mercedes** S-Class W220 (2000-2003)
- Mercedes** C-Class W203 (-2005)
- Mercedes** CLK-Class W209 (2002-)
- Mercedes** Vaneo W414



**In Universal Julie Emulator
solder jumpers**

2+3+7



Insert a 100-ohm resistor into the seat belt socket

[Back to Main Page](#)

Examples of connecting the emulator:

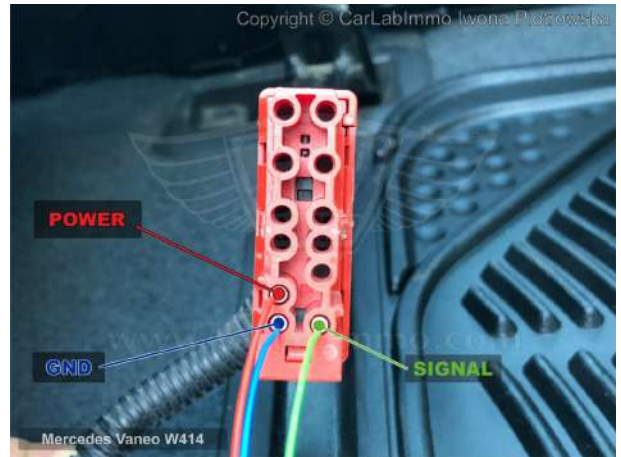
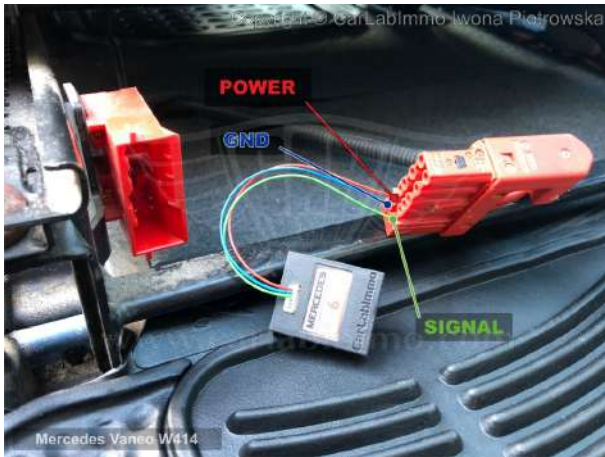
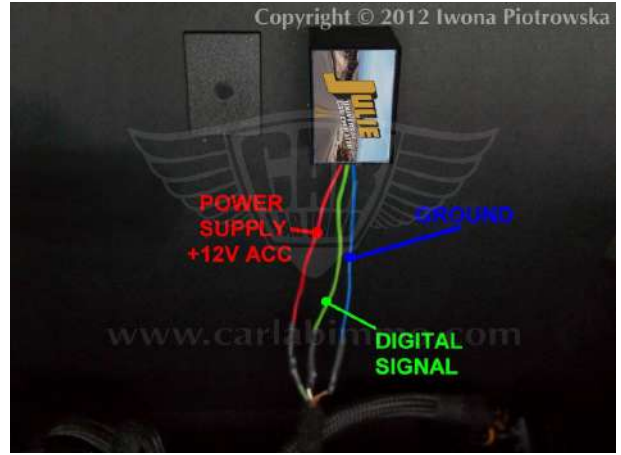
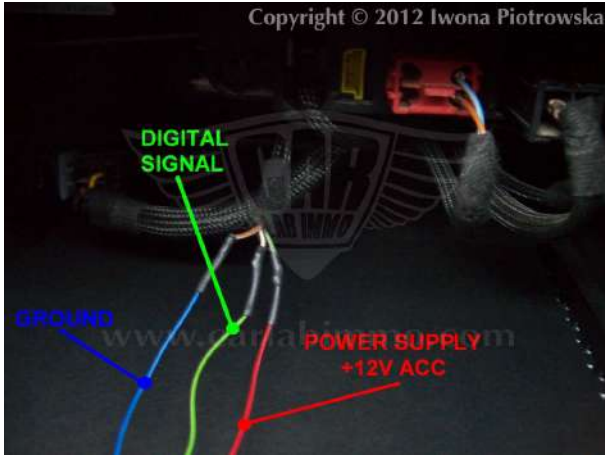

[Back to Main Page](#)

No.7 Mercedes

USE

Mercedes A-Class W168 (1997-2001)

Mercedes C-Class W202 (1999-2001)

Mercedes Vito W638 (-2003)

Mercedes ML-Class W163 with TRW controller (1999)

**Mercedes E-Class W210 before lifting-
-with airbag OFF indicator (-1999)**



**In Universal Julie Emulator
solder jumpers
3+7**



Insert a 100-ohm resistor into the seat belt socket

After correctly connecting the emulator, the SRS/AIRBAG fault on the dashboard will turn off without the need to delete the fault code.

[Back to Main Page](#)

Examples of connecting the emulator:

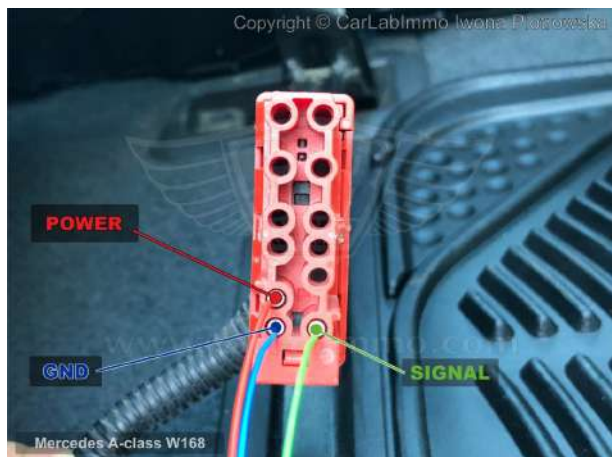
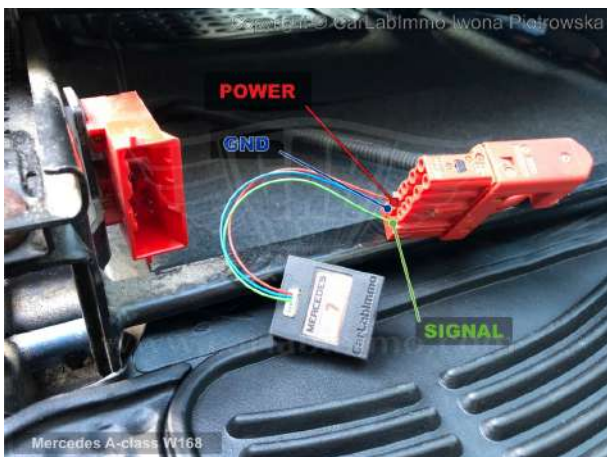
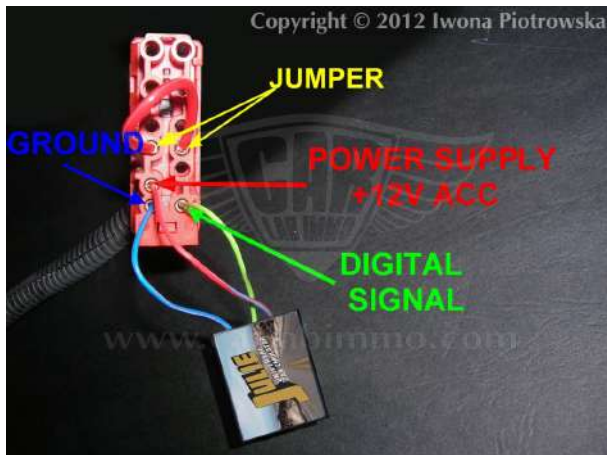

[Back to Main Page](#)

No.8 Mercedes

USE

Mercedes E-Class W212 (2009-2016)

Mercedes E-Class S212/C207/A207 (2013-2016)



**In Universal Julie Emulator
solder jumpers**

2+3+4+6+7



Insert a 100-ohm resistor into the seat belt socket

Back to Main Page

No.9 Mercedes

USE

Mercedes E-Class W211 with Temic controller (2002-2004)

Mercedes S-Class W220 (2003-2005)



In Universal Julie Emulator solder jumpers

1+2+7



Insert a 100-ohm resistor into the seat belt socket

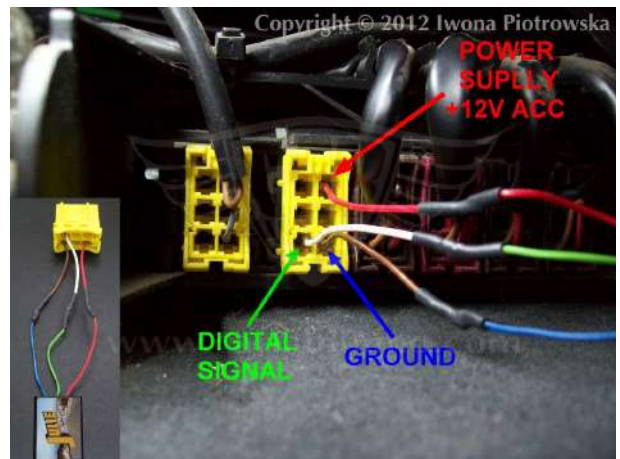
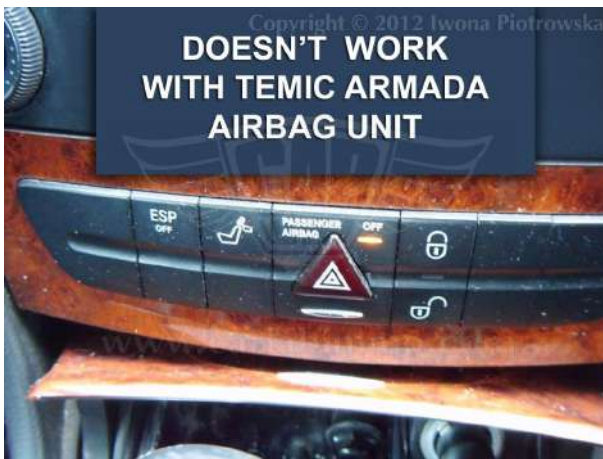

Back to Main Page

No.10 Mercedes

USE

- Mercedes E-Class W210** after lifting-
-with airbag OFF indicator(1999-2003)
- Mercedes Vito II W639** (2002-2005)
- Mercedes ML-Class W163** (2000-)
- Mercedes A-Class W168** (2002-2005)
- Mercedes S-Class W220** (2000-2003)
- Mercedes C-Class W203** (-2005)
- Mercedes CLK-Class W209** (2002-)
- Mercedes Vaneo W414**



In Universal Julie Emulator
solder jumpers

1+2+3+7



Insert a 100-ohm resistor into the seat belt socket

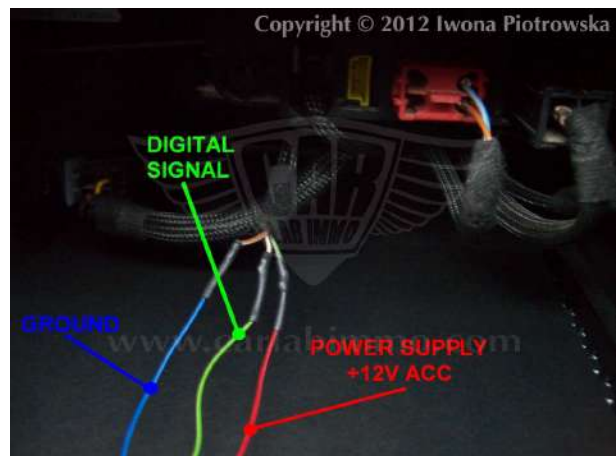
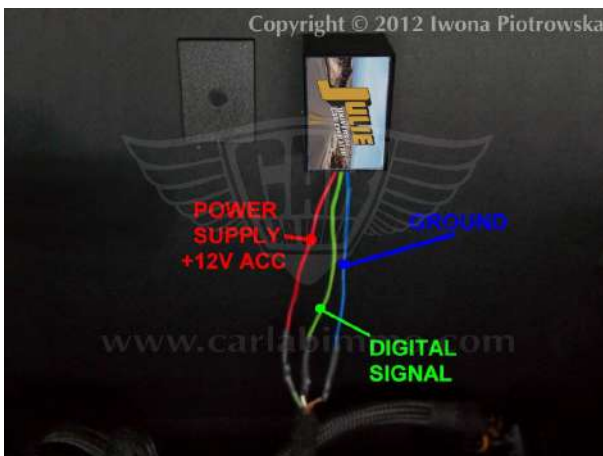

[Back to Main Page](#)

No.11 Mercedes

USE

- Mercedes A-Class W168 (1997-2001)
- Mercedes C-Class W202 (1999-2001)
- Mercedes Vito W638 (-2003)
- Mercedes ML-Class W163 with TRW controller (1999)
- Mercedes E-Class W210 before lifting-
-with airbag OFF indicator (-1999)



In Universal Julie Emulator
solder jumpers
1+3+7



Insert a 100-ohm resistor into the seat belt socket

After correctly connecting the emulator, the SRS/AIRBAG fault on the dashboard will turn off without the need to delete the fault code.

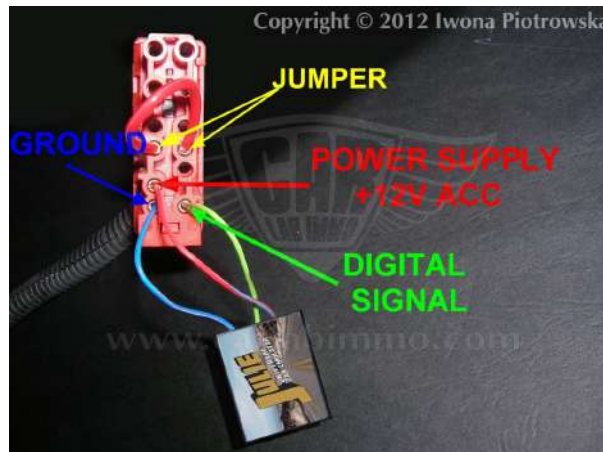

[Back to Main Page](#)

MINI

No	Model	Year	Solder jumpers	
1	Mini Cooper	2002-2005	2+4+7	OPEN
2	Mini Cooper	2002-2005	Child seat installed: 1+2+4+7	OPEN

[Back to Main Page](#)

No.1 Mini

USE

Mini Cooper (2002-2005)



In Universal Julie Emulator
solder jumpers

2+4+7



Insert a 680-ohm resistor into the seat belt socket

[Back to Main Page](#)

No.2 Mini

USE

Mini Cooper (2002-2005)



In Universal Julie Emulator
solder jumpers

1+2+4+7



Insert a 680-ohm resistor into the seat belt socket

[Back to Main Page](#)

OPEL

No.	Model	Solder jumpers	
1	Opel Corsa C Opel Vectra C	1+2+5+7	OPEN
2	Opel Astra G Opel Meriva A Opel Omega B FL, Opel Signum Opel Zafira A	3+5+7	OPEN

[Back to Main Page](#)

No.1 Opel

USE

Opel Corsa C
Opel Vectra C



**In Universal Julie Emulator
solder jumpers
1+2+5+7**



[Back to Main Page](#)

No.2 Opel

USE

Opel Astra G
Opel Meriva A
Opel Omega B FL,
Opel Signum
Opel Zafira A



**In Universal Julie Emulator
solder jumpers
3+5+7**



[Back to Main Page](#)

Warning!!!

Due to possible construction changes of cars, check signals with multimeter in the ECU plug.



All rights reserved.

Unauthorized copying, hiring, lending, public performance will be punished!

We state that we are the only authentic authors of this manual. We possess copyright of this publication. Any trials of unauthorized copying, hiring, quoting prohibited!!! Both service and advertisement constitute copyright and they are the subject to the protection in accordance with the Act from 4th Feb. 1994 on Copyright and Related Laws (Statute Book no. 24 position 93) and protection on the basis of the Act from 8th June 1993 on combating an unfair competition (Statute Book no. 47 position 211)

www.carlabimmo.com

Last updated 16.08.2018