

Trademarks

Autel®, MaxiSys®, MaxiDAS®, MaxiScan®, MaxiTPMS®, MaxiRecorder®, and MaxiCheck® are trademarks of Autel Intelligent Technology Corp., Ltd., registered in China, the United States and other countries. All other marks are trademarks or registered trademarks of their respective holders.

Copyright Information

No part of this manual may be reproduced, stored in a retrieval system or transmitted, in any form or by any means, electronic, mechanical, photocopying, recording, or otherwise without the prior written permission of Autel.

Disclaimer of Warranties and Limitation of Liabilities

All information, specifications and illustrations in this manual are based on the latest information available at the time of printing.

Autel reserves the right to make changes at any time without notice. While information of this manual has been carefully checked for accuracy, no guarantee is given for the completeness and correctness of the contents, including but not limited to the product specifications, functions, and illustrations.

Autel will not be liable for any direct, special, incidental, indirect damages or any economic consequential damages (including lost profits).

IMPORTANT

Before operating or maintaining this unit, please read this manual carefully, paying extra attention to the safety warnings and precautions.

For Services and Support:



pro.autel.com
www.autel.com



1-855-288-3587/1-855-AUTELUS (North America)
0086-755-86147779 (China)



support@autel.com

For details, please refer to the *Service Procedures* in this manual.

Safety Information

For your own safety and the safety of others, and to prevent damage to the device and vehicles upon which it is used, it is important that the safety instructions presented throughout this manual be read and understood by all persons operating or coming into contact with the device.

There are various procedures, techniques, tools, and parts for servicing vehicles, as well as in the skill of the person doing the work. Because of the vast number of test applications and variations in the products that can be tested with this equipment, we cannot possibly anticipate or provide advice or safety messages to cover every circumstance. It is the automotive technician's responsibility to be knowledgeable of the system being tested. It is crucial to use proper service methods and test procedures. It is essential to perform tests in an appropriate and acceptable manner that does not endanger your safety, the safety of others in the work area, the device being used, or the vehicle being tested.

Before using the device, always refer to and follow the safety messages and applicable test procedures provided by the manufacturer of the vehicle or equipment being tested. Use the device only as described in this manual. Read, understand, and follow all safety messages and instructions in this manual.

Safety Messages

Safety messages are provided to help prevent personal injury and equipment damage. All safety messages are introduced by a signal word indicating the hazard level.

DANGER

Indicates an imminently hazardous situation which, if not avoided, will result in death or serious injury to the operator or to bystanders.

WARNING

Indicates a potentially hazardous situation which, if not avoided, could result in death or serious injury to the operator or to bystanders.

Safety Instructions

The safety messages herein cover situations Autel is aware of. Autel cannot know, evaluate or advise you in regards of all possible hazards. You must be certain that any condition or service procedure encountered does not jeopardize your personal safety.

 **DANGER**

When an engine is operating, keep the service area WELL VENTILATED or attach a building exhaust removal system to the engine exhaust system. Engines produce carbon monoxide, an odorless, poisonous gas that causes slower reaction time and can lead to serious personal injury or loss of life.

 **It is not advised to use headphones at a high volume**

Listening at high volumes for long periods of time may result in loss of hearing.

 **Safety Warnings**

- Always perform automotive testing in a safe environment.
- Wear safety eye protection that meets ANSI standards.
- Keep clothing, hair, hands, tools, test equipment, etc., away from all moving or hot engine parts.
- Operate the vehicle in a well-ventilated work area, for exhaust gases are poisonous.
- Put the transmission in PARK (for automatic transmission) or NEUTRAL (for manual transmission) and make sure the parking brake is engaged.
- Put blocks in front of the drive wheels and never leave the vehicle unattended while testing.
- Be extra cautious when working around the ignition coil, distributor cap, ignition wires and spark plugs. These components create hazardous voltages when the engine is running.
- Keep a fire extinguisher suitable for gasoline, chemical, and electrical fires nearby.
- Do not connect or disconnect any test equipment while the ignition is on or the engine is running.
- Keep the test equipment dry, clean, and free from oil, water, and grease. Use a mild detergent on a clean cloth to clean the outside of the equipment as necessary.
- Do not drive the vehicle and operate the test equipment at the same time. Any distraction may cause an accident.
- Refer to the service manual for the vehicle being serviced and adhere to all diagnostic procedures and precautions. Failure to do so may result in personal injury or damage to the test equipment.
- To avoid damaging the test equipment or generating false data, make sure the vehicle battery is fully charged and the connection to the vehicle DLC is clean and secure.

Do not place the test equipment on the distributor of the vehicle. Strong electro-magnetic interference can damage the equipment.

CONTENTS

SAFETY INFORMATION	ii
Safety Messages	ii
SAFETY INSTRUCTIONS	ii
Safety Warnings	iii
1 USING THIS MANUAL	1
1.1 CONVENTIONS	1
1.2 BOLD TEXT	1
1.2.1 <i>Notes and Important Messages</i>	1
1.2.2 <i>Hyperlink</i>	2
1.2.3 <i>Illustrations</i>	2
1.2.4 <i>Procedures</i>	2
2 GENERAL INTRODUCTION	3
2.1 MAXISYS TABLET.....	3
2.1.1 <i>Functional Description</i>	3
2.1.2 <i>Power Sources</i>	5
2.1.3 <i>Technical Specifications</i>	6
2.2 MAXIFLASH VCI	8
2.2.1 <i>Functional Description</i>	8
2.2.2 <i>Power Sources</i>	9
2.2.3 <i>Technical Specifications</i>	10
2.3 MAXIBAS B200	11
2.3.1 <i>Functional Description</i>	11
2.4 ACCESSORIES KIT.....	12
2.4.1 <i>Main Cable</i>	12
2.4.2 <i>Non-OBDII Adapters</i>	12
2.4.3 <i>Other Accessories</i>	13
3 GETTING STARTED	16
3.1 POWER UP.....	16
3.1.1 <i>Application Buttons</i>	17
3.1.2 <i>Locator and Navigation Buttons</i>	18
3.1.3 <i>System Status Icons</i>	19
3.2 POWER DOWN.....	20
3.2.1 <i>Reboot System</i>	20
4 CV DIAGNOSTICS OPERATIONS	21

4.1 ESTABLISH VEHICLE COMMUNICATION AND SELECTION	21
4.1.1 <i>Establish Vehicle Communication</i>	21
4.1.2 <i>Getting Started</i>	25
4.1.3 <i>Vehicle Identification</i>	27
4.2 DIAGNOSTICS SCREEN LAYOUT	32
4.3 AUTO SCAN	33
4.4 CONTROL UNIT	38
4.4.1 <i>Screen Messages</i>	39
4.4.2 <i>Making Selections</i>	40
4.5 ECU INFORMATION	40
4.6 TROUBLE CODES	41
4.6.1 <i>Read Codes</i>	41
4.6.2 <i>Erase Codes</i>	43
4.7 LIVE DATA	43
4.8 ACTIVE TEST	51
4.9 SPECIAL FUNCTIONS	52
4.10 PROGRAMMING AND CODING	54
4.10.1 <i>Coding</i>	55
4.10.2 <i>Reprogramming</i>	55
4.10.3 <i>Re-flash Errors</i>	56
4.11 GENERIC OBDII OPERATIONS	57
4.11.1 <i>General Procedure</i>	57
4.11.2 <i>Function Descriptions</i>	58
4.12 DIAGNOSTICS REPORT	61
4.12.1 <i>Pre-Scan and Post-Scan</i>	61
4.12.2 <i>Diagnostic Report PDF</i>	61
4.13 EXIT DIAGNOSTICS	65
5 INTELLIGENT DIAGNOSTICS	66
5.1 ACCESSING INTELLIGENT DIAGNOSTICS	66
5.1.1 <i>Auto Scan</i>	66
5.1.2 <i>Scan System Faults</i>	68
5.1.3 <i>Access via Intelligent Diagnostics Button</i>	71
5.1.4 <i>Access via Intelligent Diagnostics Icon</i>	71
5.2 INTELLIGENT DIAGNOSTICS OPERATION	75
5.2.1 <i>Vehicle System and Detected DTC(s)</i>	75

5.2.2	Technical Service Bulletin (OEM Information).....	76
5.2.3	DTC Analysis	77
6	SERVICE.....	78
6.1	OIL RESET SERVICE.....	78
6.2	AFTERTREATMENT SERVICE.....	79
6.3	LIMIT SERVICE	80
6.4	INJECTOR SERVICE	80
6.5	SPEED & PTO SERVICE	80
6.6	VGT LEARN SERVICE.....	80
7	BATTERY TEST.....	81
7.1	TEST PREPARATION	81
7.1.1	Inspect the Battery.....	81
7.1.2	Connect the Battery Tester.....	81
7.2	IN-VEHICLE TEST	83
7.2.1	Start the test.....	83
7.2.2	Battery Test.....	84
7.2.3	Starter Test.....	86
7.2.4	Generator Test.....	87
7.3	OUT-VEHICLE TEST	88
7.3.1	Test Procedure	88
7.3.2	Test Results.....	89
8	MULTIMETER	91
8.1	SAFETY INFORMATION	91
8.2	CONNECTING THE MULTIMETER.....	92
8.3	SCREEN LAYOUT AND OPERATIONS	93
9	SETTINGS	96
9.1	UNIT.....	96
9.2	LANGUAGE	96
9.3	PRINTING SETTINGS.....	97
9.4	NOTIFICATION CENTER	98
9.5	AUTO UPDATE	98
9.6	ADAS SETTINGS.....	99
9.7	VEHICLE LIST	99
9.8	BATTERY TEST	99
9.9	COUNTRY/REGION CODE.....	100

9.10 SYSTEM SETTINGS	100
9.11 ABOUT	100
10 DATA MANAGER	101
10.1 VEHICLE HISTORY	102
10.1.1 Test Records	103
10.2 WORKSHOP INFORMATION	104
10.3 CUSTOMER	105
10.4 IMAGE	105
10.5 PDF FILES	107
10.6 REVIEW DATA	107
10.7 UNINSTALL APPS	108
10.8 DATA LOGGING	108
11 VCI MANAGER	109
11.1 VCI CONNECTION VIA WI-FI	109
11.2 VCI CONNECTION VIA BLUETOOTH	111
11.3 BAS CONNECTION VIA BLUETOOTH	112
11.4 VCI UPDATE	113
11.5 BAS UPDATE	114
12 UPDATE	115
13 SUPPORT	117
13.1 PRODUCT REGISTRATION	117
13.2 SUPPORT SCREEN LAYOUT	117
13.3 MY ACCOUNT	118
13.3.1 Personal Info	118
13.3.2 Update Info	118
13.3.3 Service Info	119
13.4 TRAINING	119
13.5 DATA LOGGING	119
13.6 FAQ DATABASE	120
14 MAXVIEWER	121
15 MAXIVIDEO	123
15.1 ADDITIONAL ACCESSORIES	123
15.1.1 MaxiVideo Camera	124
15.1.2 Imager Head Accessories	124
15.1.3 Accessory Assembly	125

15.1.4 <i>Technical Specifications</i>	126
15.2 OPERATIONS	127
16 QUICK LINK	129
17 REMOTE DESKTOP	130
17.1 OPERATIONS	130
18 USER FEEDBACK	132
19 MAINTENANCE AND SERVICE	133
19.1 MAINTENANCE INSTRUCTIONS	133
19.2 TROUBLESHOOTING CHECKLIST	133
19.3 ABOUT BATTERY USAGE	134
19.4 SERVICE PROCEDURES	135
19.4.1 <i>Technical Support</i>	135
19.4.2 <i>Repair Service</i>	136
19.4.3 <i>Other Services</i>	136
20 COMPLIANCE INFORMATION	137
21 WARRANTY	138
21.1 12-MONTH LIMITED WARRANTY	138

1 Using This Manual

This manual contains device usage instructions.

Some illustrations shown in this manual may contain modules and optional equipment that are not included in your system.

1.1 Conventions

The following conventions are used.

1.2 Bold Text

Bold text is used to highlight selectable items such as buttons and menu options.

Example:

- Tap **OK**.

1.2.1 Notes and Important Messages

Note

A **NOTE** provides helpful information such as additional explanations, tips, and comments.

Example:

NOTE

New batteries reach full capacity after approximately 3 to 5 charging and discharging cycles.

Important

IMPORTANT indicates a situation that if not avoided may result in damage to the tablet or vehicle.

Example:

IMPORTANT

Keep the cable away from heat, oil, sharp edges and moving parts. Replace damaged cables immediately.

1.2.2 Hyperlink

Hyperlinks or links that take you to other related articles, procedures, and illustrations are available in electronic documents. Blue italic text indicates a selectable hyperlink and blue underlined text indicates a website link or an email address link.

1.2.3 Illustrations

Illustrations used in this manual are samples, and the actual testing screen may vary for each vehicle being tested. Observe the menu titles and on-screen instructions to make correct option selection.

1.2.4 Procedures

An arrow icon indicates a procedure.

Example:

➤ **To use the camera:**

1. Tap the **Camera** button. The camera screen opens.
2. Focus the image to be captured in the view finder.
3. Tap the camera icon on the right side of the screen. The view finder now shows the captured picture and auto-saves the taken photo.
4. Swipe the screen left to view the stored photos.
5. Tap the **Back** or **Home** button to exit the camera application.

2 General Introduction

MaxiSys MS909CV provides the full functionality and online repair information you need when diagnosing vehicles, identifying faults and researching repair issues. It features a powerful octa-core processor and 9.7-inch TFT-LCD capacitive touchscreen for swift diagnosis and optimum viewing.

MaxiSys MS909CV has three main components:

- MaxiSys Display Tablet — the central processor and monitor for the system.
- VCI — vehicle communication interface.
- B200 — battery & electrical system tester.

This manual describes the construction and operation of these devices and how they work together to deliver diagnostic solutions.

2.1 MaxiSys Tablet

2.1.1 Functional Description

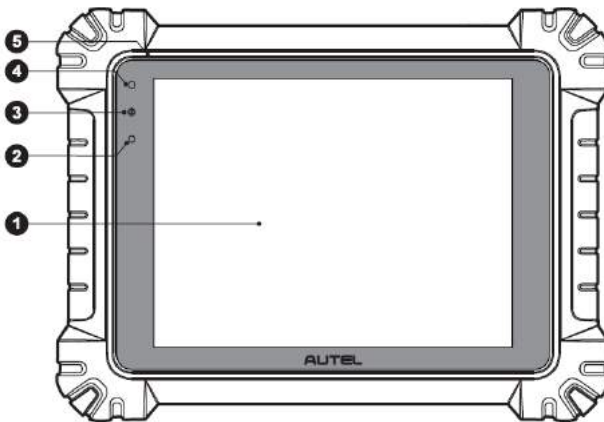

Figure 2-1 MaxiSys Tablet Front View

1. 9.7" TFT-LCD Capacitive Touchscreen
2. Ambient Light Sensor — detects ambient brightness
3. Power LED
4. Front Camera

5. Microphone

Table 2-1 Power LED Description

LED	Color	Description
Power	Green	<ul style="list-style-type: none">● Lights green when the Tablet is charging and the battery level is above 90%.● Lights green when the Tablet is powered on and the battery level is above 15%.
	Yellow	Lights yellow when the Tablet is charging and the battery level is below 90%.
	Red	Lights red when the Tablet is powered on and the battery level is below 15%.

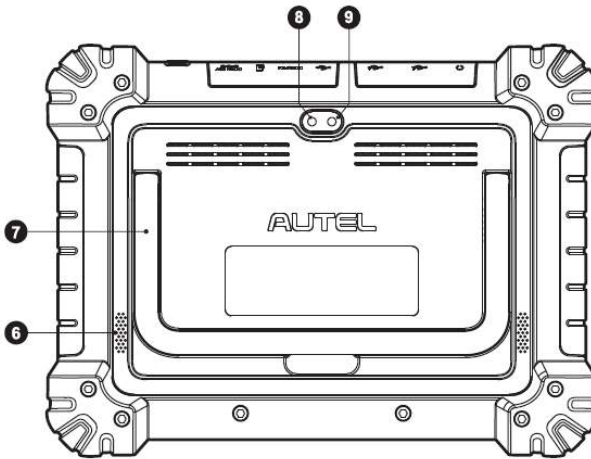

Figure 2-2 MaxiSys Tablet Back View

- 6. Speaker
- 7. Collapsible Stand — extends from the back to allow hands-free viewing of the tablet
- 8. Rear Camera
- 9. Camera Flash

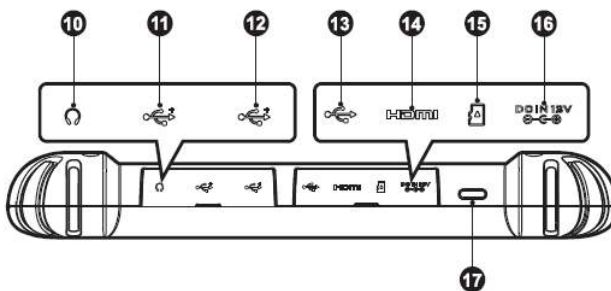

Figure 2-3 MaxiSys Tablet Top View

10. Head Phone Jack
11. USB Port
12. USB Port
13. Mini USB Port
14. HDMI (High-Definition Multimedia Interface) Port
15. Micro SD Card Slot
16. DC Power Supply Input Port
17. Lock/Power Button — long press to turn on and off the Display Tablet, or tap to lock the screen

2.1.2 Power Sources

The tablet can receive power from any of the following sources:

- Internal Battery Pack
- AC/DC Power Supply
- Vehicle Power

! IMPORTANT

Do not charge the battery when the temperature is lower than 0°C (32°F) or higher than 45°C (113°F).

Internal Battery Pack

The tablet can be powered with the internal rechargeable battery, which if fully charged can provide sufficient power for about 8 hours of continuous operation.

AC/DC Power Supply — using power adapter

The tablet can be powered from an electrical outlet using the AC/DC power adapter. The AC/DC power supply also charges the internal battery pack.

Vehicle Power

The tablet can be powered from the auxiliary power outlet adapter or other DC power port on the test vehicle through a direct cable connection. The vehicle power cable connects to the DC power supply port on the top side of the display unit.

2.1.3 Technical Specifications

Table 2-2 Tablet Specifications

Item	Description
Operating System	Android 7.0
Processor	Samsung Exynos 8895V octa-core Processor (2.3GHz Quad-core Mongoose + 1.7GHz Quad-core A53)
Memory	4GB RAM & 128GB On-board Memory
Display	9.7-inch TFT-LCD with 1536 x 2048 resolution & capacitive touch screen
Connectivity	<ul style="list-style-type: none">● WiFix2 (802.11 a/b/g/n/ac 2x2 MIMO)● Bluetooth v.2.1 + EDR● GPS● USB 2.0 (TWO USB HOST Type A, ONE USB mini device)● HDMI 2.0● SD Card (Support up to 256GB)
Camera	<ul style="list-style-type: none">● Rear: 16 Megapixel, Autofocus with Flashlight● Front: 5.0 Megapixel
Sensors	Gravity Accelerometer, Ambient Light Sensor (ALS)
Audio	<ul style="list-style-type: none">● Microphone● Dual Speakers

Item	Description
Input/Output	<ul style="list-style-type: none"> ● 3-Band 3.5 mm stereo/standard headset jack
Power and Battery	<ul style="list-style-type: none"> ● 15000mAh 3.8V lithium-polymer battery ● Charging via 12V AC/DC power supply with the temperature between 0°C and 45°C
Input Voltage	12V/3A Adapter
Operating Temp.	0 to 50°C (32 to 122°F)
Storage Temp.	-10 to 60°C (14 to 140°F)
Dimensions (WxHxD)	304.4 mm (11.98") x 227.8 mm (8.97") x 42.5 mm (1.67")
Weight	1.66 kg (3.66 lb.)
Protocols	<p>DoIP, PLC J2497, ISO-15765, SAE-J1939, ISO-14229 UDS, SAE-J2411 Single Wire Can (GMLAN), ISO-11898-2, ISO-11898-3, SAE-J2819 (TP20), TP16, ISO-9141, ISO-14230, SAE-J2610 (Chrysler SCI), UART Echo Byte, SAE-J2809 (Honda Diag-H), SAE-J2740 (GM ALDL), SAE-J1567 (CCD BUS), Ford UBP, Nissan DDL UART with Clock, BMW DS2, BMW DS1, SAE J2819 (VAG KW81), KW82, SAE J1708, SAE-J1850 PWM (Ford SCP), SAE-J1850 VPW (GM Class2)</p>

2.2 MaxiFlash VCI

2.2.1 Functional Description

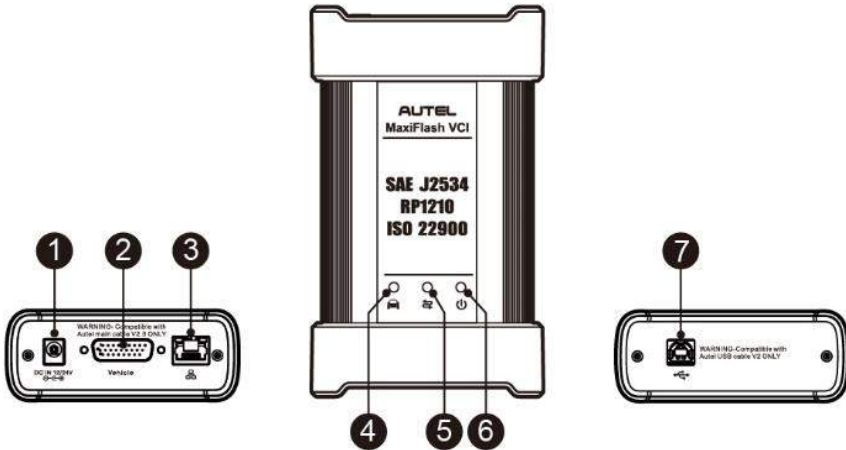

Figure 2-4 MaxiFlash VCI Programming Device

1. DC Power Supply Input Port
2. Vehicle Data Connector
3. Ethernet Port
4. Vehicle LED
5. Connection LED
6. Power LED
7. USB Port

Table 2-3 LED Description

LED	Color	Description
Power LED	Yellow	The VCI is powered on and performing self-check.
	Green	The VCI is ready for use.
	Red	<ul style="list-style-type: none"> ● Lights solid red when system failure occurs. ● Flashes red when the VCI is upgrading.
Vehicle LED	Green	Flashes green when communicating with the vehicle.

LED	Color	Description
Connection LED	Green	Lights solid green when the VCI is connected via USB cable.
	Cyan	Lights solid cyan when the VCI is connected via Wi-Fi.
	Blue	Lights solid blue when the VCI is connected via Bluetooth.

ⓘ IMPORTANT

Do not disconnect the programming device while the vehicle LED status light is on. If the flash programming procedure is interrupted while the vehicle's ECU is blank or only partially programmed, the module may be unrecoverable.

Programming Capability

The MaxiFlash VCI device is a D-PDU, SAE J2534 & RP1210 compliant PassThru programming interface device. Using the updated OEM software, it is capable of replacing the existing software/firmware in the Electronic Control Units (ECU), programming new ECUs, and fixing software-controlled drivability issues and emission issues.

Communication Capability

The MaxiFlash VCI device supports Bluetooth, Wi-Fi, and USB communications. It can transmit vehicle data to the tablet with or without a cable connection. In open areas, the working range of the transmitter through Bluetooth communication is up to 328 feet (about 100 m). The working range of 5G Wi-Fi is up to 164 feet (50 m). If the signal is lost due to being taken out of range, communication will be restored once the tablet is within range.

2.2.2 Power Sources

The VCI device can receive power from the following sources:

- Vehicle Power
- AC/DC Power Supply

Vehicle Power

The VCI device operates on 12/24 Volt vehicle power, which receives power via the vehicle data connection port. The device powers on whenever it is connected to an OBDII/EOBD compliant data link connector (DLC). For non OBDII/EOBD compliant vehicles, the device can be powered from an auxiliary power outlet adapter or other suitable power port on the test vehicle using the auxiliary power cable.

AC/DC Power Supply

The VCI device can be powered from a wall socket using the AC/DC power adapter.

2.2.3 Technical Specifications

Table 2-4 MaxiFlash VCI Specifications

Item	Description
Communications	<ul style="list-style-type: none">● Bluetooth V2.1 + EDR● USB 2.0● Wi-Fi 5G● Ethernet
Wireless Frequency	5 GHz
Input Voltage Range	12 V DC to 24 V DC
Supply Current	<ul style="list-style-type: none">● 170 mA @12 V DC● 100 mA @ 24 V DC
Operating Temp.	0°C to 50°C
Storage Temp.	-20°C to 60°C
Dimensions (L x W x H)	168.6 mm (5.87") x 99.7 mm (3.38") x 38 mm
Weight	0.399 kg (0.88 lb.)

NOTE

For additional information, please refer to the accompanied user manual for the VCI device.

2.3 MaxiBAS B200

2.3.1 Functional Description

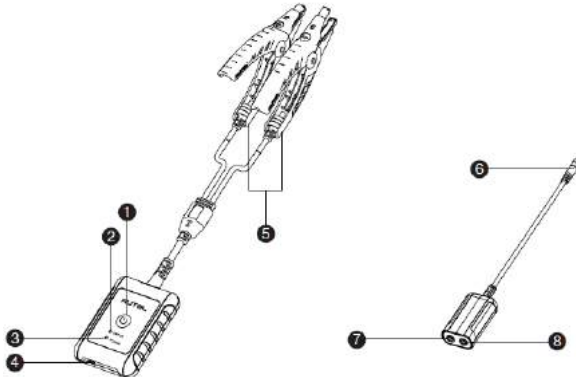

Figure 2-5 MaxiBAS B200 Device

1. Power Button
2. Status LED
3. Power LED
4. USB Port
5. Battery Clamp Cable
6. Aviation Plug
7. Positive Clamp Cable Port
8. Negative Clamp Cable Port

Table 2-5 LED Description

LED	Color	Description
Status LED	Green	<ul style="list-style-type: none">● Solid Green: The tester is connected via USB cable.● Flashing Green: The tester is communicating via USB cable.
	Blue	<ul style="list-style-type: none">● Solid Blue: The tester is connected via Bluetooth.● Flashing Blue: The tester is communicating via Bluetooth.
	Red	Flashing Red: Battery clamps are connected to the wrong battery terminals.

LED	Color	Description
Power LED	Green	<ul style="list-style-type: none"> ● Solid Green: The tester is powered on and the battery is sufficiently charged. ● Flashing Green: The tester is charging; turns to solid green after its battery is fully charged.
	Red	Flashing Red: The tester's battery level is low. Please charge.

2.4 Accessories Kit

2.4.1 Main Cable

The VCI device can be powered through the Autel Main Cable V2.0 (the V2.0 icon can be seen on the cable) when connected to an OBDII/EODB compliant vehicle. The Main Cable connects the VCI device to the vehicle's data link connector (DLC), through which the VCI device can transmit vehicle data to the tablet.

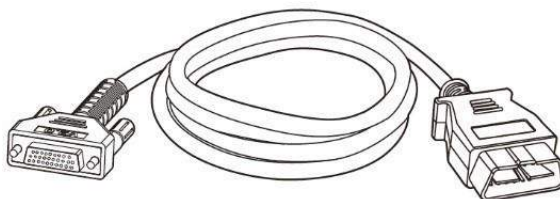

Figure 2-6 Main Cable – 1.5m in Length

NOTE

MaxiFlash VCMI and MaxiFlash VCI can be connected by the Autel Main Cable V2.0 only. DO NOT use other Autel main cables to connect the MaxiFlash VCMI and MaxiFlash VCI.

2.4.2 Non-OBDII Adapters

The adapter used depends on the type of vehicle being tested. The most common adapters are shown below.



Deutsch-9



Deutsch-6



UNI-4

UNI-4 instructions

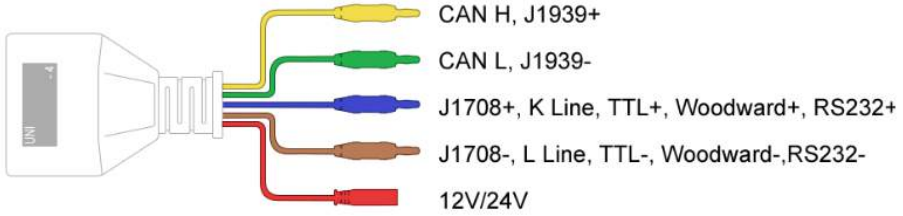

Choose the appropriate JW1/JW2/JW3/JW4/JW5/JW6/JW7/JW8/JW9/JW10 that matches DLC to connect with UNI-4.

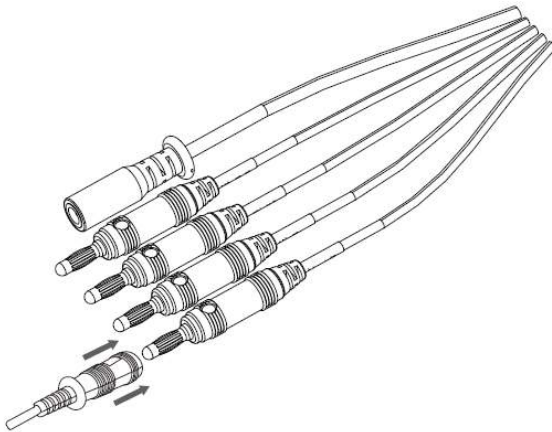

2.4.3 Other Accessories



AC/DC Adapter (12V)

Connects the tablet to the external DC power port for power supply.



USB 2.0 Cable V2

Connects the tablet to the VCI unit.



Mini USB Cable

Connects the Display Tablet to the PC.



Clipper Cable

Provides power to the Display Tablet or the VCI device, through connection to the vehicle's battery.



Auxiliary Power Outlet Adapter

Provides power to the tablet or the VCI device through connection to the vehicle auxiliary power outlet adapter receptacle, as some non-OBDII vehicles cannot provide power via the DLC connection.



Clipper Cable

Provides power to the tablet or the J2534 programming device through connection to the vehicle battery.

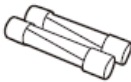

Spare Fuse x2

A safety device for the auxiliary power outlet adapter.



400A Current Clamp

Used to measure AC or DC current up to 400A.



Multimeter Test Lead x2

Used to connect the multimeter and multimeter probe.

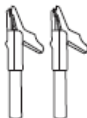

Alligator Clip x2

Designed for connecting exposed wires or terminals.



Multimeter Probe x2

Designed for connecting exposed wires or terminals.

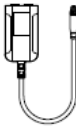

DM100

Digital Multimeter (Not available alone).

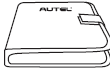

Case

The Case contains the following pins: JW1 x2, JW2 x2, JW3 x2, JW4 x2, JW5 x2, JW6 x2, JW7 x2, JW8 x2, JW9 x2, JW10 x2.

3 Getting Started

Make sure the tablet has sufficient power or is connected to the external power supply (see [Power Sources](#)).

3.1 Power Up

Long press the **Lock/Power** button on the top right side of the tablet to switch the unit on. The system boots up and shows the lock screen with 3 entry options.

1. MaxiSys Home — Swipes up the MaxiSys Home icon to enter the MaxiSys Job Menu shown as below.
2. Unlock — Swipes up the Lock icon at the center to unlock the screen or enter the MaxiSys Job Menu when booting up.
3. Camera — Swipes up the Camera icon to launch the camera.

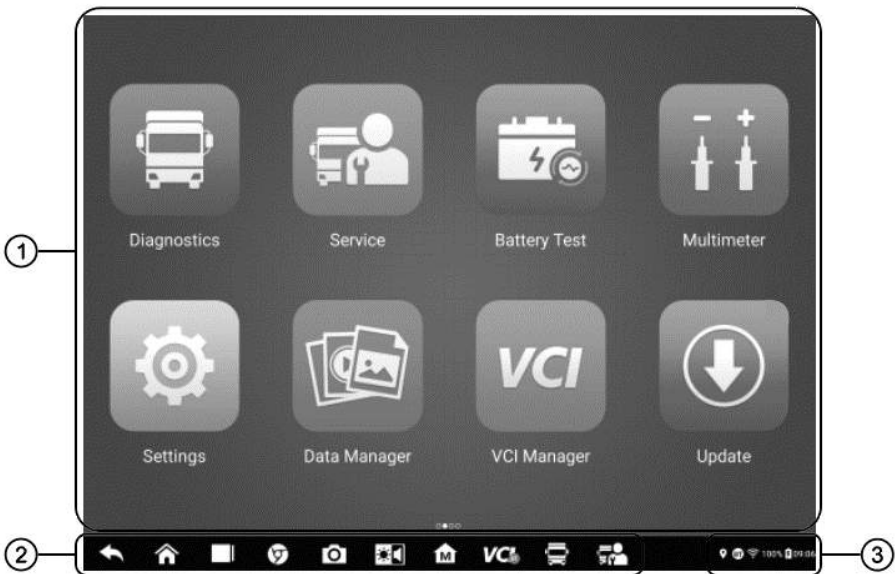

Figure 3-1 Sample MaxiSys Job Menu

1. Application Buttons
2. Locator and Navigation Buttons
3. Status Icons

NOTE









It is recommended to lock the screen when not in use to protect information in the system and conserve the power.





Almost all operations on the tablet are controlled through the touchscreen. The touchscreen navigation is menu driven, which allows you to quickly locate the test procedure or data that you need, through a series of questions and options. Detailed descriptions of the menu structures can be found in the chapters for each application.

3.1.1 Application Buttons

The table below briefly describes each of the applications in the MaxiSys system.

Table 3-1 Applications





Name	Button	Description
Diagnostics		Accesses the unit's diagnostic functions. See CV Diagnostics Operations .
Service		Accesses special functions menu. See Service .
Battery Test		Conducts battery and cranking/charging systems analysis and enables technicians to view the health status of vehicle's battery and electrical system. See Battery Test .
Multimeter		Conduct a multi-function, multi-range measurement. See Multimeter .
Settings		Accesses the system settings menu and general tablet menu. See Settings .
Data Manager		Accesses the saved repair shop, customer and vehicle data including detailed vehicle diagnostics and test records. See Data Manager .
VCI Manager		Accesses VCI connection menu. See VCI Manager .
Update		Accesses system software update menu. See Update .
Support		Synchronizes Autel's online service database with the MaxiSys tablet. See Support .







Name	Button	Description
MaxiViewer		Provides a quick search for supported functions and/or vehicles. See MaxiViewer .
MaxiVideo		Configures the unit to operate as a video scope device by connecting to an imager head cable for close vehicle inspections. See MaxiVideo .
Quick Link		Provides associated website bookmarks to allow quick access to product update, service, support and other information. See Quick Link .
Remote Desktop		Configures your unit to receive remote support using the TeamViewer application. See Remote Desktop .
User Feedback		Allows you to submit questions related to this product. See User Feedback .

3.1.2 Locator and Navigation Buttons

Operations of the Navigation buttons at the bottom of the screen are described in the table below:

Table 3-2 Locator and Navigation Buttons

Name	Button	Description
Locator		Indicates the location of the screen. Swipe the screen left or right to view the previous or next screen.
Back		Returns to the previous screen.
Android Home		Returns to Android System's Home screen.
Recent Apps		Displays a list of applications that are currently running. Tap an app icon to launch. Remove an app by swiping it to the right.
Browser		Launches the Chrome Internet browser.

Name	Button	Description
Camera		Tap icon to open camera viewfinder. Press and hold icon to capture a screenshot of the display screen. The saved files are auto-stored in the Data Manager application for later review. See Data Manager .
Display&Sound		Adjusts the brightness of the screen and the volume of the audio output.
MaxiSys Home		Returns to MaxiSys Job Menu.
VCI		Opens the VCI Manager application. A green icon at the bottom right corner indicates the VCI device is connected, while a red cross icon will display if connection fails.
MaxiSys Shortcut		Returns to the Diagnostics screen.
Service		Returns to the Service screen.

➤ **To use the camera**

1. Tap the **Camera** button. The camera screen opens.
2. Focus the image to be captured in the view finder.
3. Tap the camera icon on the right side of the screen. The viewfinder now shows the captured picture and auto-saves the taken photo.
4. Swipe the screen left to view the stored photos.
5. Tap the **Back** or **Home** button to exit the camera application.

 **NOTE**

After swiping the camera screen from left to right, the camera mode and video mode can be switched by tapping the blue camera icon or video icon.

Refer to Android documentation for additional information.

3.1.3 System Status Icons

Your MaxiSys tablet is a fully functional Android tablet with the standard Android operation system status icons. Refer to Android documentation for additional information.

3.2 Power Down

All vehicle communications should be terminated before shutting down the tablet. A warning message displays if a shutdown is attempted while the tablet is communicating with the vehicle. Forcing a shutdown while the tablet is communicating with the vehicle may lead to ECU problems on some vehicles. Please exit the Diagnostics application before shutting off the tablet.

➤ **To power down the MaxiSys tablet**

1. Press and hold the **Lock/Power** button.
2. Tap **Power off** option.
3. Tap **OK**.

3.2.1 Reboot System

In case of system crash, press and hold the **Lock/Power** button and tap **Reboot** to restart the system.

4 CV Diagnostics Operations

The Diagnostics application can access the electronic control module of multiple vehicle control systems, including but not limited to the engine, transmission, anti-lock brake system (ABS), and airbag system (SRS).

4.1 Establish Vehicle Communication and Selection

4.1.1 Establish Vehicle Communication

The Diagnostics operations require connecting the MaxiSys MS909CV tablet to the test vehicle through the VCI device using the Main Cable (Use the applicable Non-OBd type adapter if needed). To establish proper vehicle communication with the tablet, you need to perform the following steps:

1. Connect the VCI device to the vehicle's DLC for both communication and power source.
2. Connect the VCI device to the tablet via Bluetooth, Wi-Fi or USB connection.
3. When the above steps are completed, check the VCI navigation button at the bottom bar on the screen. If a green Bluetooth, Wi-Fi or USB icon appears at the lower-right corner, the MaxiSys MS909CV Diagnostic Platform is ready to start vehicle diagnosis.

4.1.1.1 Vehicle Connection

The method used to connect the VCI device to a vehicle's DLC depends on the vehicle's configuration as follows:

- A vehicle equipped with an On-board Diagnostics Two (OBdII) management system supplies both communication and 12-volt/24-volt power through a standardized J-1962 DLC.
- A vehicle not equipped with an OBdII management system supplies communication through a DLC connection, and in some cases supplies 12-volt power through the auxiliary power outlet or a connection to the vehicle battery.

OBdII Vehicle Connection

This type of connection only requires the main cable without any additional adapter.

➤ To connect to an OBdII vehicle

1. Connect the main cable's female adapter to the Vehicle Data Connector on the VCI device and tighten the captive screws.

2. Connect the cable's 16-pin male adapter to the vehicle's DLC, which is generally located under the vehicle dashboard.

 **NOTE**

The vehicle's DLC is not always located under the dashboard; refer to the user manual of the test vehicle for additional connection information.

Non-OBDII Vehicle Connection

This type of connection requires both the main cable and a Deutsch-9/Deutsch-6/UNI-4 adapter for the specific vehicle being serviced.

There are three possible scenarios for Non-OBDII vehicle connection:

- DLC connection supplies both communication and power.
- DLC connection supplies communication and power is supplied via the auxiliary power outlet adapter connection.
- DLC connection supplies communication and power is supplied via the vehicle battery.

➤ **To connect to a Non-OBDII Vehicle**

1. Connect the main cable's female adapter to the Vehicle Data Connector on the VCI device, and tighten the captive screws.
2. Locate the required Deutsch-9/Deutsch-6/UNI-4 adapter and connect its 16-pin jack to the main cable's male adapter.
3. Connect the attached Deutsch-9/Deutsch-6/UNI-4 adapter to the vehicle's DLC.

 **NOTE**

Some vehicles may have more than one adapter or may have test leads instead of an adapter. Make the proper connection to the vehicle DLC as required.

➤ **To connect the auxiliary power outlet adapter**

1. Plug the DC power connector of the auxiliary power outlet adapter into the DC power supply input port on the device.
2. Connect the male connector of the auxiliary power outlet adapter to the vehicle's auxiliary power outlet.

➤ **To connect the clipper cable**

1. Connect the tubular plug of the clipper cable to the male connector of the auxiliary power outlet adapter.

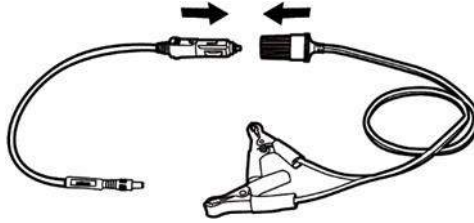

Figure 4-1 Connection between Auxiliary Power Outlet Adapter and Clipper Cable

2. Plug the DC power connector of the auxiliary power outlet adapter into the DC power supply input port of the VCI device.
3. Connect the clipper cable to the vehicle's battery.

NOTE

After the VCI device is successfully connected to the vehicle, the Power LED on the device will light solid green, and a beeping sound will be heard.

4.1.1.2 VCI Connection

After the VCI device is properly connected to the vehicle, the Power LED on the VCI device lights solid green, and is ready to establish communication with the tablet.

The VCI device is supplied with the MaxiSys MS909CV tool kit. The VCI device supports three communication methods with the tablet: Bluetooth, Wi-Fi and USB.

Pairing via Bluetooth

In open areas, the working range for Bluetooth communication is about 328 feet (100 m), giving technicians greater mobility to perform vehicle diagnosis from anywhere in the repair shop.

To expedite multi-vehicle diagnostics, more than one VCI can be used in busy repair shops, enabling technicians to quickly pair their MaxiSys tablet to each VCI separately via Bluetooth and therefore eliminating the need to unplug the VCI from one vehicle and then connect it to another each time.

➤ To pair the tablet with the VCI device via Bluetooth

1. Power up the tablet.
2. Select the **VCI Manager** application from the MaxiSys Job Menu.
3. When the **VCI Manager** application is opened, the device automatically scans for available VCI devices for Bluetooth pairing. Available devices are listed in the Setting section on the right side of the screen.

NOTE

If no VCI device is found, this may indicate that the signal strength is too weak to be detected. Reposition the VCI device and remove all possible objects that may cause signal interference. Tap the **Scan** button at the top right corner to rescan for the VCI.

4. Typically, the VCI device name appears as “Maxi” suffixed with the device serial number. Select the VCI device for pairing. (If more than one VCI is used in the shop, ensure the correct VCI is selected for pairing.)
5. When pairing is successful, the connection status appears as “Connected”.
6. The VCI icon on the tablet navigation bar on the bottom appears as a green circle Bluetooth icon when the tablet and the VCI are connected.

Wi-Fi Connection

The VCI device supports 5 GHz Wi-Fi connection. In open areas, the working range of 5G Wi-Fi communication is up to 164 feet (50 m).

➤ To connect the tablet with the VCI device via Wi-Fi

1. Power up the tablet.
2. Select the **VCI Manager** application from the MaxiSys Job Menu.
3. When the **VCI Manager** application is opened, the tablet automatically scans for available VCI devices for Wi-Fi connection. Found VCI devices are listed in the Setting section on the right side of the screen.
4. Typically, the VCI device name appears as “Maxi” suffixed with the device serial number. Select the required device for connection.
5. When connection is successful, the connection status is shown as “Connected”.
6. The VCI icon on the tablet navigation bar at the bottom appears as a green circle Wi-Fi icon when the tablet and the VCI are connected.

USB Cable Connection

The USB cable connection is a simple and quick way to establish communication between the tablet and the VCI device. After properly connecting the tablet to the VCI device using the USB cable, the VCI navigation button at the bottom bar of the screen displays a green check mark and the USB LED on the VCI device lights solid green, indicating the connection between the devices is successful.

The MaxiSys diagnostic platform is now ready to perform vehicle diagnosis.

🔗 NOTE

Since the USB connection provides the most stable communication and is therefore the recommended communication method between the tablet and VCI when operating ECU programming or coding. The USB communication method will take priority over other communication methods.

4.1.1.3 No Communication Message

- A. If the tablet is unable to connect to the VCI, an “error” message appears. An “error” message indicates the tablet is not communicating with the VCI device. Troubleshoot the error by performing the following steps:

- Ensure the VCI device is powered on.
 - When using the wireless connection, ensure the network is configured correctly and the proper device has been connected.
 - If the tablet loses communication abruptly during the diagnosis, ensure no objects are causing signal interruption.
 - Ensure the VCI device is properly positioned with the VCI front side facing upward.
 - Move the tablet closer to the VCI device. If using the wired connection, ensure the cable is securely attached to the VCI.
 - Ensure the VCI communication mode is lit for the selected communication type: Bluetooth, Wi-Fi or USB.
- B. If the VCI device is unable to establish a communication link, a message will display troubleshooting instructions. Possible causes for the communication error include:
- A vehicle system has been selected for diagnosis that is not supported by the vehicle.
 - There is a loose connection.
 - There is a blown vehicle fuse.
 - The vehicle or the data cable has a wiring fault.
 - There is a circuit fault in the data cable or adapter.
 - The vehicle information entered is incorrect.

4.1.2 Getting Started

Prior to first use of the Diagnostics application, ensure the VCI device is properly connected to and is communicating with the tablet. See [VCI Manager](#).

4.1.2.1 Vehicle Menu Layout

When the VCI device is properly connected to the vehicle and the tablet, the platform is ready to start vehicle diagnosis. Tap on the **Diagnostics** application button on the MaxiSys Job Menu, the Vehicle Menu will appear on the screen.

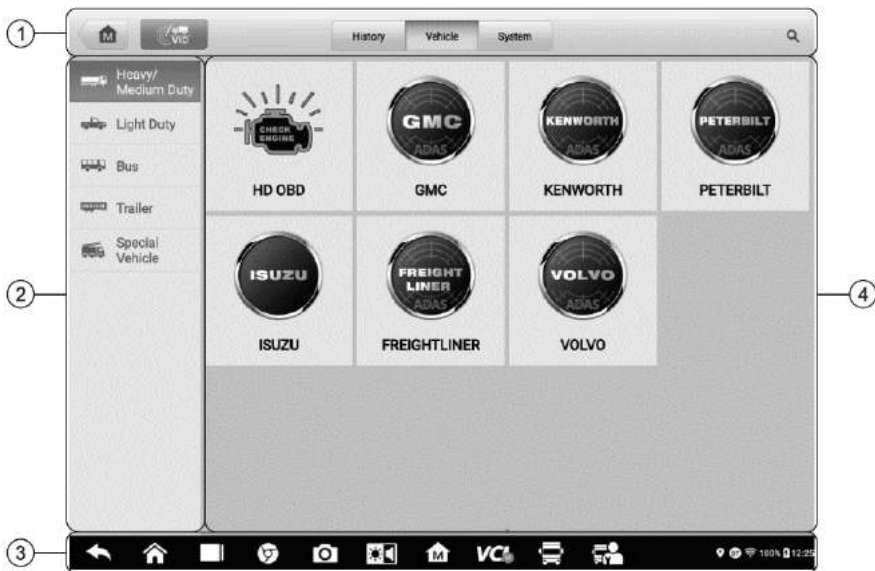



Figure 4-2 Sample Vehicle Menu Screen



1. Top Toolbar Buttons
2. CV Band Vehicles
3. Locator and Navigation Buttons
4. Manufacturer Buttons

Top Toolbar Buttons

The operations of the Toolbar buttons at the top of the screen are listed and described in the table below:

Table 4-1 Top Toolbar Buttons

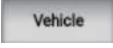
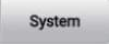
Name	Button	Description
Home		Returns to the MaxiSys Job Menu.
VID Scan		Tap this button to open a dropdown list; tap Auto Detect for auto VIN detection; tap Manual Input to enter VIN code or license number manually. Tap Scan VIN/License to scan the VIN code/license number by camera.

Name	Button	Description
History		Displays the stored test vehicle records. This option provides you with direct access to the previously tested vehicle recorded during previous test sessions. See Vehicle History .
Vehicle		Displays the vehicles such as Heavy/Medium Duty, Light Duty, Bus, Trailer, AGRIC, Trailer in the vehicle menu.
System		Displays the major commercial vehicle system manufacturers.
Search		Touching this button opens the virtual keyboard, allowing you to manually enter the specific vehicle make.

Manufacturer Buttons

The Manufacturer buttons display the various vehicle brand. To start a diagnostic session, select the proper manufacturer button after the VCI device is properly connected to the test vehicle.

4.1.3 Vehicle Identification

The MaxiSys MS909CV diagnostic system supports five methods of Vehicle Identification.

1. Auto Detect
2. Manual Input
3. Scan VIN/License
4. Manual Vehicle Selection
5. OBDII Direct Entry

4.1.3.1 Auto Detect

The MaxiSys MS909CV diagnostic system features the latest VIN-based AutoVIN Scan function to identify CAN vehicles with just one tap, enabling the technician to quickly identify the exact vehicle and scan its available systems for fault codes.

➤ To perform an AutoVIN Scan

1. Tap the **Diagnostics** application button from the MaxiSys Job Menu. The Vehicle Menu displays.

2. Tap the **VID Scan** button on the top toolbar.
3. Select **Auto detect**. The tablet starts VIN scanning on the vehicle's ECU. Once the test vehicle is successfully identified, the system will guide you to the CV Diagnostics screen directly.

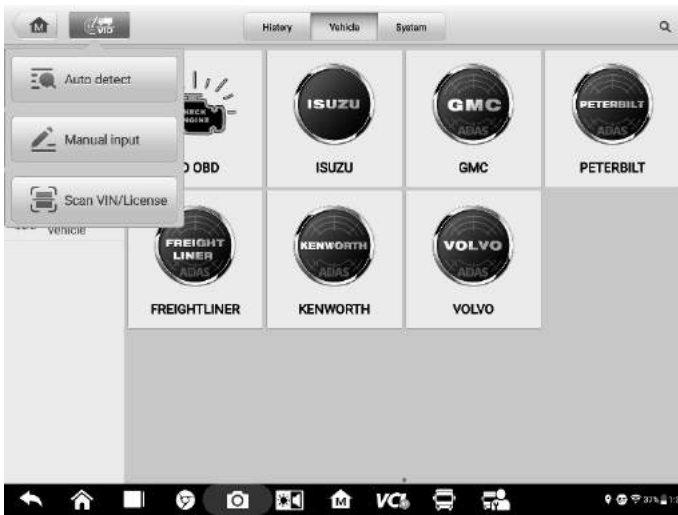

Figure 4-3 Sample Auto Detect Screen

In some cases, when you have selected the vehicle brand instead of performing AutoVIN Scan in the first place, the system still provides the AutoVIN Scan option.

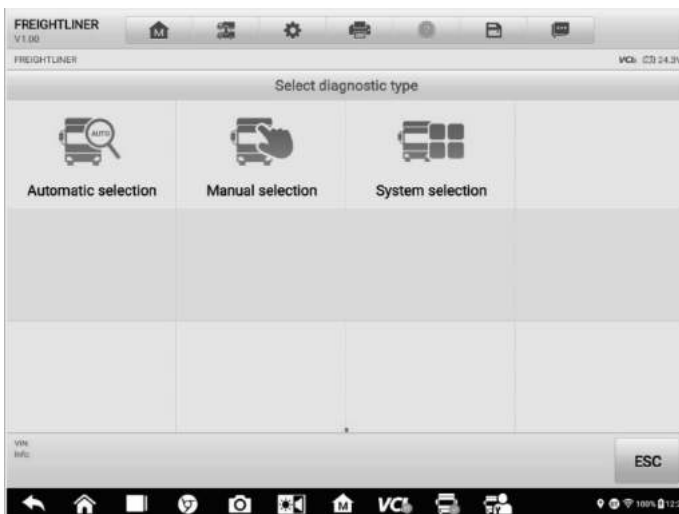

Figure 4-4 Sample Automatic Selection Screen

Select **Automatic Selection** and the system will acquire VIN information automatically or allow users to input the VIN manually.

4.1.3.2 Manual Input

For some vehicles that do not support the AutoVIN Scan function, the MaxiSys CV Diagnostics system allows you to enter the vehicle VIN manually, or simply take a photo of the VIN sticker for quick vehicle identification.

➤ To perform Manual Input

1. Tap the **Diagnostics** application button from the MaxiSys Job Menu. The Vehicle Menu displays.
2. Tap the **VID Scan** button on the top toolbar.
3. Select **Manual input**.
4. Tap the input box and enter the correct VIN code or license number.



Figure 4-5 Sample Manual VIN Input

5. Tap **OK**. The vehicle will be identified and matched to the vehicle database and the Vehicle Diagnostics screen will appear.
6. Tap the cross icon on the top-right corner to exit Manual Input.

4.1.3.3 Scan VIN/License

Tap **Scan VIN/License** in the dropdown list (Figure 4-3), the camera will launch. On the right side of the screen, from top to bottom, three options are available: **Scan bar code**, **Scan VIN**, and **Scan License**.

NOTE

The Scan License option is supported in limited countries and areas. If not available, manually enter the license number.

Select one of three options and position the tablet to align the VIN or license number within the scanning window, the result appears in the Recognition dialog box after scanned. Tap **OK** to confirm the result, and then the vehicle information confirmation screen will appear on the tablet. If all the vehicle information is correct, tap the icon in the middle of the screen to confirm the VIN of the vehicle being tested. Tap **OK** to continue.

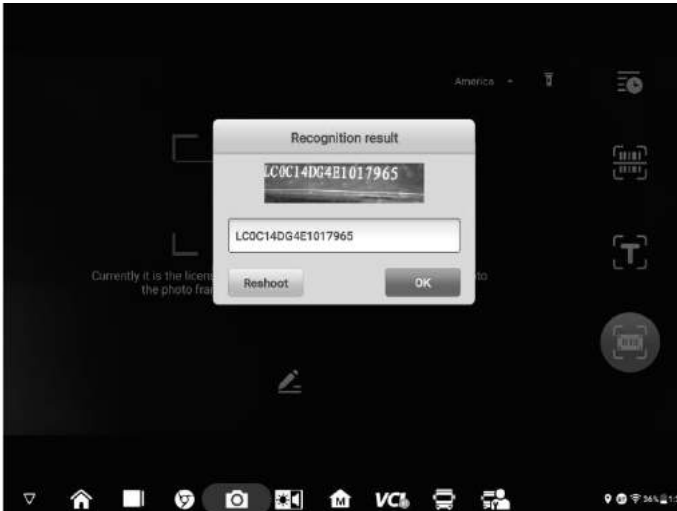

Figure 4-6 Sample Scan VIN Code

If the VIN/License number can't be scanned, please manually enter it. Tap **OK** to continue. Manually enter the license number and select a vehicle brand in the vehicle information confirmation screen. Tap the icon in the middle of the screen to confirm the VIN of the vehicle being tested. Tap **OK** to continue.

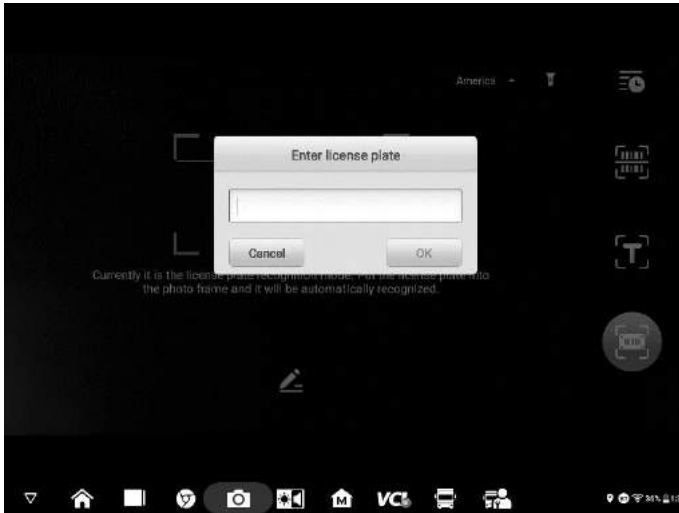

Figure 4-7 Sample Manually Enter License Number

4.1.3.4 Manual Vehicle Selection

When the vehicle's VIN is not automatically retrievable through the vehicle's ECU, or the specific VIN is unknown, you can select the vehicle manually.

Manual Vehicle Selection

This mode of vehicle selection is menu driven. Select the **Manufacturer** icon on the Vehicle Menu screen and the 'Select Diagnostic Type' screen appears. Then tap the **Manual Selection** button. Select the vehicle information like the Brand, Model, Capacity, Engine Type and Model Year on the same screen. Each selection you make advances you to the next screen. The **Esc** button at the lower right corner of the screen will bring you back to the previous screen. Tap the **Reset** button to reselect the vehicle information, if needed.

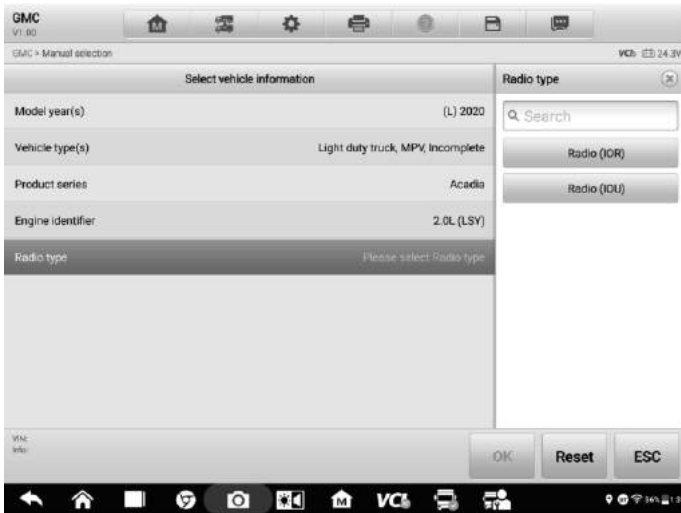

Figure 4-8 Sample Manual Vehicle Selection Screen

4.1.3.5 Alternative Vehicle Identification

Occasionally, the tablet may not be able to identify a vehicle. For these vehicles, the user may perform a generic OBDII or EOBD diagnostics. See [Generic OBDII Operations](#) for additional information.

4.2 Diagnostics Screen Layout

After the vehicle information is selected, tap the **OK** button at the bottom-right corner of the screen to open the Main menu page. This section consists of various commonly used functions, including Auto Scan and Control Unit. The available functions displayed vary by vehicle.

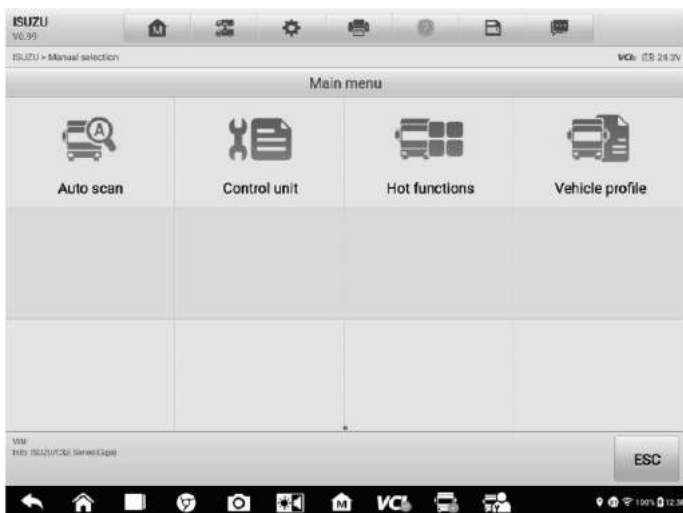

Figure 4-9 Sample Main Menu Screen

4.3 Auto Scan

The Auto Scan function performs a comprehensive scanning of all the systems in the vehicle ECU to locate faults and retrieve DTCs. Tap **Fault Scan** to start. Systems with no faults detected will appear in green; systems containing faults will appear orange.

➤ To perform the Auto Scan function

Using topology for GMC as an example:

1. Tap the **Diagnostics** application button on the MaxiSys Job Menu. Choose the corresponding vehicle information and enter the Vehicle Diagnostics page.
2. Select **Auto Scan** on the Main menu to enter the diagnostics interface.
3. The Topology tab page displays in the main section. Tap the **Fault Scan** button at the bottom of the screen to scan the vehicle system modules.
4. A system scanned with no faults detected appears in green; a system scanned with faults detected will appear in orange. The number of total faults will appear on the upper-right corner.

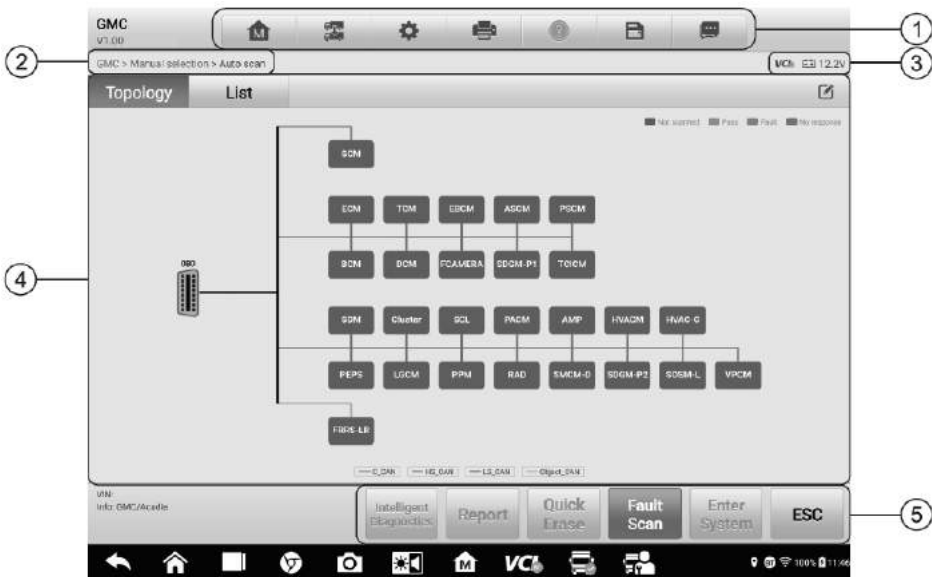



Figure 4-10 Sample Auto Scan Screen

NOTE



On the Auto Scan screen, there is a **Select System** icon  on the upper-right corner. Select the corresponding system(s) to scan will save more time than scanning all systems.





1. Diagnostics Toolbar
2. Current Directory Path
3. Status Information Bar
4. Main Section
5. Function Buttons

Diagnostics Toolbar

The Diagnostics Toolbar contains buttons that allow you to print or save the displayed data and perform other operations. The table below provides a brief description for the operations of the Diagnostics toolbar buttons:

Table 4-2 Diagnostics Toolbar Buttons

Name	Button	Description
Home		Returns to the MaxiSys Job Menu.
Vehicle Swap		Exits the diagnostic session and returns to the vehicle menu screen to select another vehicle for testing.

Name	Button	Description
Settings		Opens the Settings screen. See Settings .
Print		Saves and prints a copy of the displayed data. See Printing Settings .
Help		Provides instructions or tips for operations of various diagnostic functions.
Save		<p>Opens a submenu for the 2 options to save data:</p> <ul style="list-style-type: none"> • Tap Save This Page to take a screenshot image • Tap Save All Data to save a PDF file (use this save option when data displays on multiple screens) <p>These files are stored in Data Manager application for later reviews. See Data Manager.</p>
Data Logging		Tap to display the error options. Select a specific abnormal type, and a submission form will appear to let you enter the report information.

➤ **To print data in Diagnostics**

1. Tap the **Diagnostics** application button on the MaxiSys Job Menu. The **Print** button in the diagnostics toolbar is available throughout the whole Diagnostics operations.
2. Tap **Print** and a drop-down menu displays.
 - **Print This Page** — prints a screenshot copy of the current screen.
 - **Print All Data** — prints a PDF copy of all displayed data.
3. A temporary file will be created and sent via the computer to the printer.
4. When the file is sent, a confirmation message displays.

 **NOTE**

Make sure the tablet and the printer are connected either by Wi-Fi or LAN before printing. For more instructions on printing, see [Printing Settings](#).

➤ **To submit Data Logging reports in Diagnostics**

1. Tap the **Diagnostics** application button from the MaxiSys Main Screen. The **Options** button on the diagnostic toolbar is available throughout the whole Diagnostics operations.
2. Tap the **Options** button to display the error options. Select a specific error, and a submission form will display to let you fill in the report information.
3. Tap the **Send** button in the upper-right corner of the screen to submit the report

form via the Internet, a confirmation message displays when sent successfully.

Current Directory Path

The Directory Path shows all directory names to access the current page.

Status Information Bar

The Status Information Bar at the top of the Main Section displays the following items:

1. **VCI Icon** — indicates the communication status between the tablet and the VCI device.
2. **Battery Icon** — indicates the battery status of the vehicle.

Main Section

The Main Section varies depending on the stage of operations which shows vehicle identification selections, the main menu, test data, messages, instructions and other diagnostic information.

The Main Section of Auto Scan screen displays both a System List for most vehicles and a topology map for some makes, including KENWORTH, Peterbilt, Chevrolet.

A. Topology Tab Page

The Topology Tab page displays a system distribution diagram of the vehicle control modules.

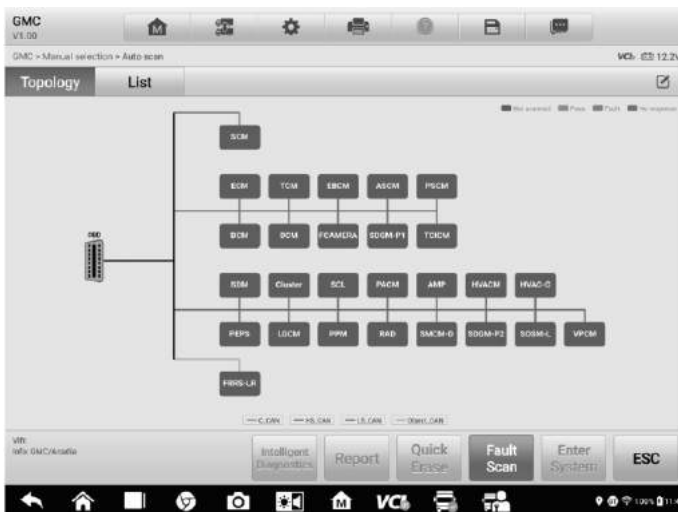

Figure 4-11 Sample Topology Tab Page

B. List Tab Page

Column 1 — displays the system numbers.

Column 2 — displays the scanned systems.

Column 3 — displays the scan results.

- ❖ **Fault | #:** Indicates there is/are fault code(s) detected; “#” indicates the quantity of detected faults.
- ❖ **Pass | No Fault:** Indicates the system was scanned and no faults detected.
- ❖ **Not Scanned:** Indicates the system has not been scanned; or indicates that the vehicle control system has been detected, but the tester cannot access it.
- ❖ **No Response:** Indicates the system has not received a response, or that the scanned system may not support the code-reading function, or that there is a communication error between the tester and the control system.
- ❖ **Pause:** Pauses the scanning process.

Column 4 — tap to enter the corresponding system.

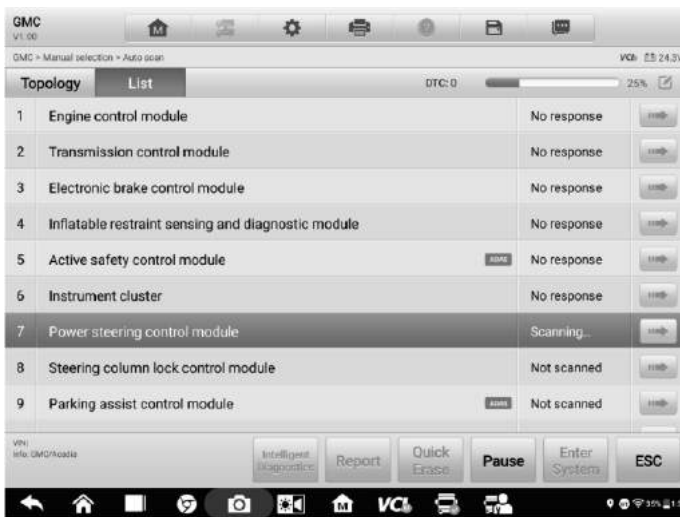

Figure 4-12 Sample List Tab Page

Function Buttons

The type of Function Buttons displayed at the bottom of the screen vary by operation. Functions include pause, reporting, code clearing, exit scanning, and other function controls. The functions of these buttons will be described in the following sections when relevant.

The table below provides a brief description of the Function Buttons' operations:

Table 4-3 Function Buttons in Diagnostics Screen

Name	Description
Intelligent Diagnostics	Directly accesses the Intelligent Diagnostics function to view the fault code analysis information of ALL DTCs. See <i>Intelligent Diagnostics Operation</i> .
Report	Displays the diagnostic data in the report form.
Quick Erase	Erases all fault information after scanning.
Fault Scan	Scans vehicle system modules for fault codes.
Pause	Pauses the scanning process.
Enter System	Enters the ECU system.
ESC	Returns to the previous screen or exits the Diagnostics Screen.

Select one of the system modules from Topology or List and tap **Enter System** to enter the specific system functions.

 **NOTE**

The Diagnostic Buttons Toolbar (located on the top of the screen) will be active throughout the diagnostic session for tasks such as printing and saving the displayed data, Bluetooth pairing help, or performing data logging.

4.4 Control Unit

The **Control Unit** allows you to manually locate a required control system for testing through a series of choices. Follow the menu driven procedure, and the program will guide you to the **Diagnostic Function** menu.



Figure 4-13 Sample Function Menu Screen

Available functions may vary by vehicle. The function menu may include:

- **ECU Information** — displays detailed ECU information. Select to display information screen.
- **Trouble Codes** — contains Read Codes and Erase Codes. The former displays detailed DTC information retrieved from the vehicle control module, the latter allows you to erase DTCs and other data from the ECU.
- **Live Data** — retrieves and displays live data and parameters from the vehicle's ECU.
- **Active Tests** — provides specific subsystem and component tests. This selection may display as *Actuators*, *Actuator Test*, or *Function Tests*. Available tests vary by vehicle.
- **Special Functions** — provides component adaptation or variant coding functions for custom configurations, and allows entry of adaptive values for certain components after repairs. Depending on the test vehicle, this selection may sometimes appear as *Control Unit Adaptations*, *Variant Coding*, *Configuration* or something similar.

4.4.1 Screen Messages

Messages appear when additional input is needed before proceeding. There are mainly three types of on-screen messages: Confirmation, Warning, and Error.

- **Confirmation Messages**

This type of message usually appears as an "Information" screen, when you are about to perform an action that cannot be reversed or when an action has been initiated and your confirmation is needed to continue.

When a user-response is not required, the message displays briefly.

- **Warning Messages**

This type of message appears when completion the selected action may result in an irreversible change or loss of data. An example of this message is the "Erase Codes" message.

- **Error Messages**

Error messages appear when a systemic or procedural error has occurred. Possible errors include cable disconnection and communication interruption.

4.4.2 Making Selections

The Diagnostics application is a menu driven program that presents a series of options one at a time. As you select from a menu, the next menu in the series appears. Each selection narrows the focus and leads to the desired test. Use your fingertip to make menu selections.

4.5 ECU Information

This function retrieves and displays the specific information for the tested control unit, including unit type and version numbers.



Figure 4-14 Sample ECU Information Screen

1. Diagnostics Toolbar Buttons — see [Table 4-2 Diagnostics Toolbar Buttons](#) for detailed descriptions of the operations of each button.
2. Current Directory Path
3. Status Information Bar
4. Main Section — the left column displays the item names; the right column displays the specifications or descriptions.
5. Function Button — in this case, only the **ESC** button is available; tap it to exit after viewing.

4.6 Trouble Codes

4.6.1 Read Codes

This function retrieves and displays DTCs from the vehicle control system. The Read Codes screen varies for each vehicle being tested. For some vehicles, freeze frame data can also be retrieved for viewing. A sample Read Codes screen displays as below:



Figure 4-15 Sample Read Codes Screen

1. Diagnostics Toolbar — see [Table 4-2 Diagnostics Toolbar Buttons](#) for details.
2. Current Directory Path
3. Status Information Bar
4. Main Section
 - Column 1 — displays the retrieved codes from the vehicle.
 - Column 2 — indicates the status of the retrieved codes.
 - Column 3 — detailed descriptions for the retrieved codes.
 - Column 4 — provides access to the Intelligent Diagnostics screen.
5. Function Buttons
 - **Intelligent Diagnostics** — tap to enter the Intelligent Diagnostics screen to check related repair cases and help information.
 - **Freeze Frame** —  icon displays when freeze frame data is available for viewing. Tap the icon to display the data screen. The Freeze Frame screen is similar to that of the Read Codes interface and share similar operations.
 - **Search** — tap to search the selected DTC for additional information on the Internet.
 - **Erase codes** — tap to erase codes from the ECU. It is recommended that DTCs are read and needed repairs are performed before erasing codes.
 - **Read codes** — retrieves and displays the DTCs from the vehicle control system. The Read Codes screen varies for each vehicle being tested.
 - **ESC** — tap to return to the previous screen or exit the function.

4.6.2 Erase Codes

After reading the retrieved codes from the vehicle and certain repairs having been made, you can erase the codes from the vehicle using this function. Before performing this function, make sure the vehicle's ignition key is in the ON (RUN) position with the engine off.

➤ To erase codes

1. Tap **Erase Codes** in the Function Menu.
2. A warning message appears to inform you of data loss when this function is applied.
 - a) Tap **Yes** to continue. A confirmation screen appears when the operation is successfully done.
 - b) Tap **No** to exit.
3. Tap **ESC** on the confirmation screen to exit Erase Codes.
4. Check the Read Codes function again to ensure the operation is successful.

4.7 Live Data

When this function is selected, the screen displays the data list for the selected module. The parameters appear in the order that they are transmitted by the ECU, so expect variation among vehicles.

Gesture scrolling allows you to quickly move through the data list. Drag your finger up or down on the screen to reposition the parameters being displayed if the data occupies more than one screen. The figure below displays a typical Live Data screen:

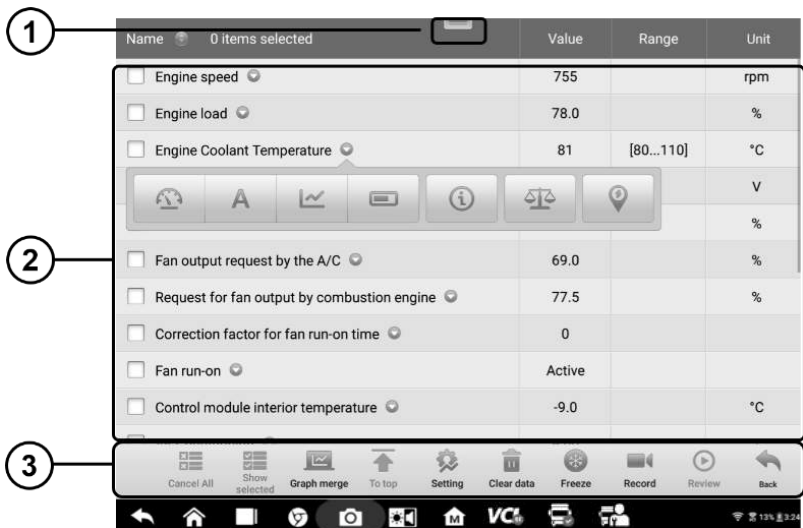

Figure 4-16 Sample Live Data Screen

1. **Diagnostics Toolbar Buttons** — tap the toolbar menu icon at the top of the screen to display diagnostics toolbar buttons. See [Table 4-2 Diagnostics Toolbar Buttons](#) for detailed descriptions of each button.

2. Main Section

- Name Column — displays the parameter names.
 - a) Check Box — tap the check box to the left of a parameter name to select the item. Tap the check box again to deselect it.
 - b) Drop-down Button — tap the drop-down button on the right side of the parameter to open a submenu, which provides optional modes that display the data.
- Value Column — displays the values of the parameters.
- Range Column — displays the range of the parameters.
- Unit Column — displays the units of the parameter values.
 - To change the Unit mode, tap the **Settings** button in the top toolbar and select a required mode. See [Unit](#).

Display Mode

There are four types of display modes available for data viewing, allowing you to view various parameters in the mode best suited to represent the data.

Tap the drop-down button on the right side of the parameter name to open a submenu. A total of 7 buttons will be displayed: The 4 buttons on the left represent different data display modes, plus an **Information** button (active when additional information is available), an **Unit**

Change button (for switching the unit of displayed data), and a **Trigger** button (tap to open the "Trigger Settings" window).

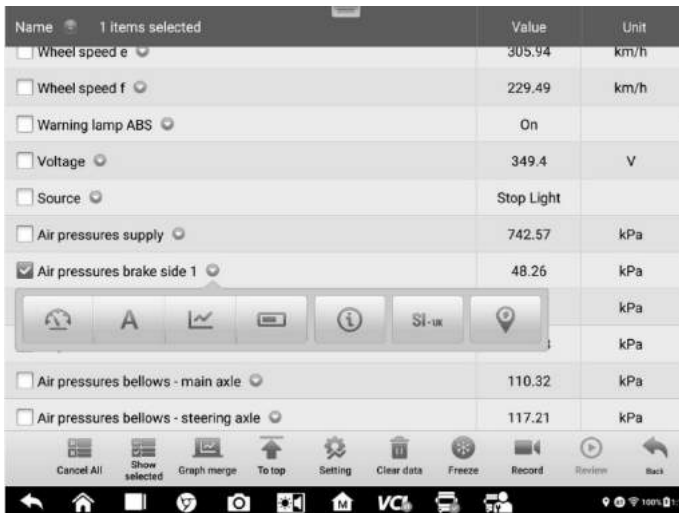

Figure 4-17 Sample Display Mode Screen

Each parameter displays the selected mode independently.

- ✧ **Analog Gauge Mode** — displays the parameters in gauge charts.
- ✧ **Text Mode** — the default mode that displays the parameters as a text list.

NOTE

Some status parameters, such as a switch reading like ON, OFF, ACTIVE, and ABORT, can only be displayed in Text Mode. Others, such as a sensor reading, can be displayed in both text and graph modes.

- ✧ **Waveform Graph Mode** — displays the parameters in waveform graphs.

In this mode, five control buttons will appear on the right side of the parameter item, allowing you to manipulate the display status.

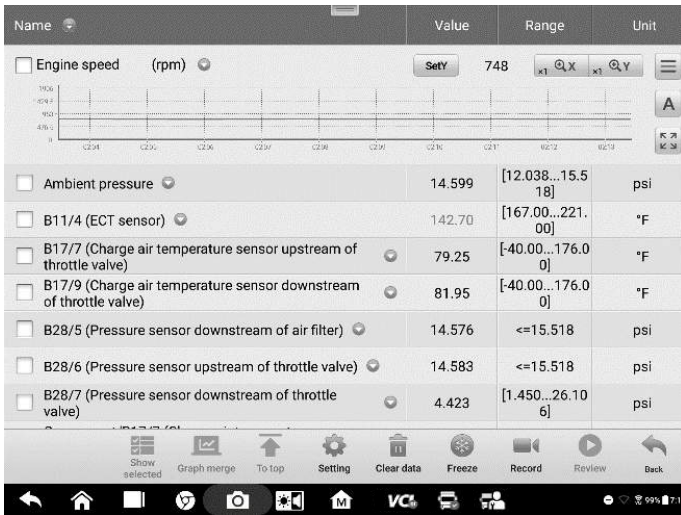

Figure 4-18 Sample Waveform Graph Mode Screen

1. **Settings Button (SetY)** — sets the minimum and maximum value of the Y axis.
2. **Scale Button** — changes the scale values.

There are two scale buttons displaying above the waveform graph to the right side, which can be used to change the scale values of the X axis and Y axis of the graph. There are four scales available for the X axis: x1, x2, x4 and x8, and three scales available for the Y axis: x1, x2, and x4.

3. **Edit Button** — edit the waveform color and line thickness.
4. **Zoom-in Button** — tap once to display the selected data graph in full screen.
5. **Exit Button** — tap to exit the waveform graph mode.

Full Screen Display — this option is only available in the waveform graph mode, and is mostly used in Graph Merge status for data comparison. There are three control buttons available on the top right side of the screen under this mode.

- Scale Button — tap to change the scale values below the waveform graph. There are four scales available for the X axis: x1, x2, x4 and x8. There are three scales available for the Y axis: x1, x2, and x4.
- Edit Button — tap to open an edit window, in which you can set the waveform color and the line thickness displayed for the selected parameter.
- Zoom-out Button — tap to exit full screen display.
- Exit Button — tap to exit the waveform graph mode.

➤ **To edit the waveform color and line thickness in a data graph**

1. Select parameters to display in Waveform Graph mode.
2. Tap the **Edit** Button and an edit window will appear.

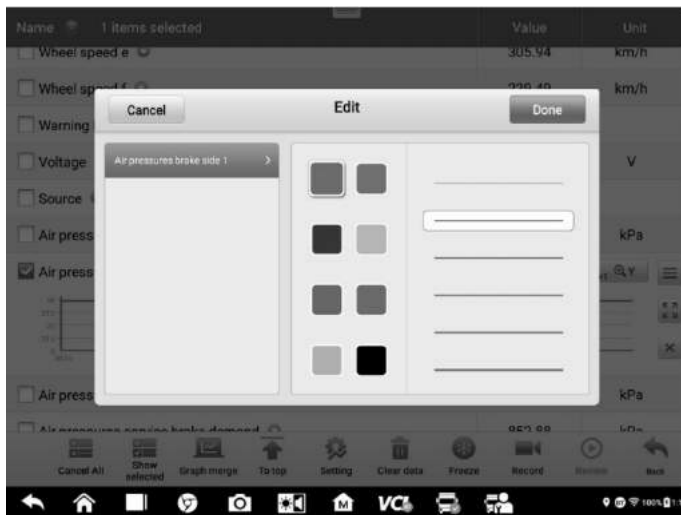

Figure 4-19 Sample Waveform Edit Screen

3. The parameter is selected automatically in the left column.
4. Select a color from the second column.
5. Select a line thickness from the right column.
6. Tap **Done** to save the settings and exit, or tap **Cancel** to exit without saving.

NOTE

In full screen display, you can edit the waveform color and line thickness by tapping the **Edit** button on the upper-right side of the screen.

✧ **Digital Gauge Mode** — displays the parameters in the form of a digital gauge graph.

Trigger Settings

Tap the drop-down button on the right side of the parameter to open a submenu. The **Trigger** button is the last one in the submenu. Tap to display the Trigger Settings window.

On the trigger setting screen, you can set a standard range by filling in a minimum value and a maximum value. When exceeding this range, the trigger function will be executed and the device will automatically record and save the generated data. You can review the saved live data by tapping the **Review** button at the bottom of the screen.

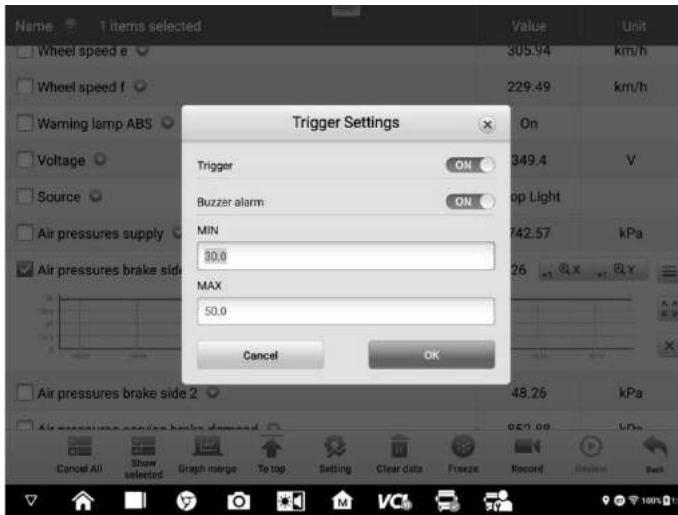

Figure 4-20 Sample Trigger Settings Screen

Two buttons and two input boxes are available in the Trigger Settings window.

- a) **Trigger** — switches the trigger on and off. The trigger is ON by default.
- b) **Buzzer Alarm** — switches the alarm on and off. The alarm function makes a beeping sound as an alert when the data reading reaches the preset minimum or maximum point. The buzzer alarm will only sound at the first trigger.
- c) **MIN** — tap this input box to display a virtual keyboard to enter the required lower threshold value.
- d) **MAX** — tap this input box to display a virtual keyboard to enter the required upper threshold value.

➤ **To set a trigger**

1. Tap the drop-down button on the right side of the parameter to open a submenu.
2. Tap the **Trigger** button on the right side of the submenu to open the Trigger Settings window.
3. Tap the **MIN** button on the right side, and enter the required minimum value.
4. Tap the **MAX** button on the right side, and enter the required maximum value.
5. Tap **OK** to save the settings and return to the Live Data screen, or tap **Cancel** to exit without saving.

When the trigger is set, a trigger mark appears in front of the parameter. The mark is gray when it is not triggered, and turns orange when triggered. Moreover, two horizontal lines appear on each of the data graphs (when Waveform Graph Mode is applied) to

indicate the alarm point. The threshold lines are shown in different colors to differentiate them from the parameter waveforms.

3. Function Buttons

The operations of all available function buttons on the Live Data screen are described below:

- ✧ **Cancel All** — tap to cancel all selected parameters. Up to 50 parameters can be selected at one time.
- ✧ **Show Selected/Show All** — tap to switch between the two options; one displays the selected parameters, the other displays all the available items.
- ✧ **Graph Merge** — tap this button to merge selected data graphs (for Waveform Graph Mode only). This function is very useful when comparing different parameters.

NOTE

This mode supports the merging of 2 to 5 parameters from different graphs. Only quantitative parameters are supported.

➤ **To merge selected data graphs**

- 1) Select parameters to be merged.
- 2) Tap the **Graph Merge** button at the bottom of the Live Data screen.
 - a) This mode only supports parameters that can be represented digitally. If non-digital parameters are selected, a message will display advising the user that the selected parameters are not supported in this mode and to select 2 to 5 digital parameters. Tap **Got It** button to return to the previous screen and select supported parameters.
 - b) When unsupported parameters are selected, a message will appear advising the user to selected only parameters that are supported. A message will also appear if more than 5 parameters have been selected. Please select 2 to 5 of the supported parameters and tap **OK** button to merge.
- 3) Tap **Cancel Merging** button at the bottom of the Live Data screen to cancel merge.

✧ **To Top** — moves a selected data item to the top of the list.

✧ **Setting** — tap this button to set recording duration. Five options are available: 5 seconds, 15 seconds, 30 seconds, 60 seconds and 90 seconds.

➤ **To set live data record duration**

1. Tap **Setting** button at the bottom of the Live Data screen.
2. Tap the > button to the right of **Recording time after trigger** bar and select a time length.

3. Tap **OK** to save the settings and return to the Live Data Setting screen; or tap the “**X**” button at the upper-right corner to exit without saving.
4. Tap **Done** at the upper-right corner of the Live Data Setting screen to confirm and save the settings, and return to the Live Data screen, or tap **Cancel** to exit without saving.

- ✧ **Clear Data** — tap to clear all cached live data.
- ✧ **Freeze** — displays a still capture retrieved data.
 - Previous Frame – moves to the previous frame of frozen data.
 - Next Frame — moves to the next frame of frozen data.
 - Play/Pause — tap to play/pause the frozen data.
 - Resume — tap to exit the freeze data mode and return to normal data display.
- ✧ **Record** — starts recording the live data of the selected data items. Tap the **Record** button at the bottom of the Live Data screen. A message will display prompting user to select parameters to record. Tap **Got It** button to confirm. Scroll down and select data to record. Tap the **Record** button to start recording. Tap **Resume** button to stop recording. The recorded live data can be viewed in the **Review** section at the bottom of the Live Data screen or in the **Data Manager** application.
 - Resume — tap to stop data recording and to return to normal data display.
 - Flag — this button appears when the Record function is applied. Tap to set flags to note points of interest when recording data. Notes can be added during playback in Review or *Data Manager*. Select the preset flag to open a popup window and display a virtual keyboard to input notes.
- ✧ **Review** — review the recorded data. Tap Review button to display a recording list, and select an item to review.

NOTE

Only the data recorded during the current operation can be reviewed on the Live Data screen. All the historical recorded data can be reviewed in "Review Data" in the Data Manager application.

- Previous Frame — switches to the previous frame of recorded data.
 - Next Frame — switches to the next frame of recorded data.
 - Play/Pause — tap to play/pause the recorded data.
 - Show Selected — displays the selected parameter items.
 - Graph Merge — merges selected data graphs.
 - Back — exits the review, and returns to the Live Data screen.
- ✧ **Back** — returns to the previous screen or exits the function.

4.8 Active Test

The Active Test function is used to access vehicle-specific subsystem and component tests. Available tests vary by vehicle.

During an active test, the tablet sends commands to the ECU to activate the actuators. This test determines the integrity of the system or part by reading ECU data or by monitoring the operation of the actuators. Such tests may include toggling a solenoid, relay, or switch, between two positions.

Selecting Active Test displays a menu of test options. Available tests vary by vehicle. Select test from the menu options. Follow the instructions displayed on the screen to complete the test. Procedures and instructions vary by vehicle.



Figure 4-21 Sample Active Test Screen 1



Figure 4-22 Sample Active Test Screen 2

The function buttons in the lower-right corner of the Active Test screen manipulate the test signals. The operational instructions are displayed in the main section of the test screen. Follow the on-screen instructions and make appropriate selections to complete the tests.

Tap the **ESC** button to exit the test when finished.

4.9 Special Functions

These functions perform various component adaptations, including the recalibration or configuration of certain components after repairs or replacements have been completed.

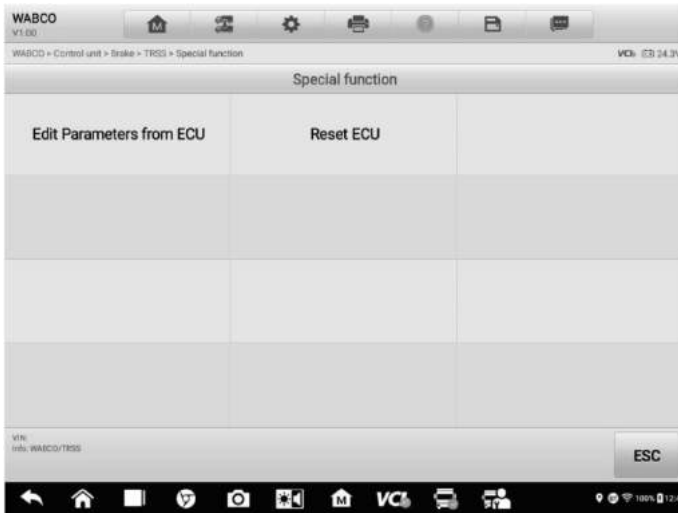

Figure 4-23 Sample Special Function Screen 1

Select a function to display detailed information and execution screen.



Figure 4-24 Sample Special Function Screen 2

Tap the function buttons to perform the selected function or exit the function.

4.10 Programming and Coding

Since the introduction of OBDII and leading up to modern Hybrids and EVs, hardware and software technologies in cars have been advancing at an exponential rate. Updating software may be the only way to fix the following issues:

- Drivability
- Fuel Efficiency
- Power Loss
- Fault Codes
- Durability of Mechanical Parts

The Programming and Coding function is used to “re-flash” the vehicle control modules, which allows you to update the computer software of the vehicle to the latest version, as well as to reprogram adaptive data of certain components after making repairs or replacements.

NOTE

The programming function applies only when the vehicle is connected with a VCI device, which serves as a PassThru interface to establish communication with and transfer data to the vehicle's ECU.

Available programming or coding operations vary by test vehicle. Only the available operations display in the tablet menu.

There are two general types of programming operations:

- A. Coding — also known as *Teach-in Program*, or *Component Adaptation*, is used to reprogram adaptive data for vehicle control modules after repairs or replacements of vehicle parts.
- B. Reprogramming — downloads the latest version of software from the online server database via the Internet access (this procedure is done automatically when the tablet is connected to the Internet, so there is no need to check for software updates yourself), and reprograms the newest version into the vehicle's ECU.

NOTE

Ensure that the tablet is connected to a stable internet access before launching the ECU programming function, so that the tablet is able to access the vehicle manufacturer's server for update service.

Selecting the Programming or Coding function opens a menu of operation options that varies by vehicle make and model. Selecting a menu option either displays a programming interface or opens another menu of additional choices. Follow all screen instructions while performing the programming or coding operations. How and what information is presented on the screen vary by the type of operation being performed.

4.10.1 Coding

The main section of the Coding screen displays a list of vehicle components and the coding information that mainly consists of two parts:

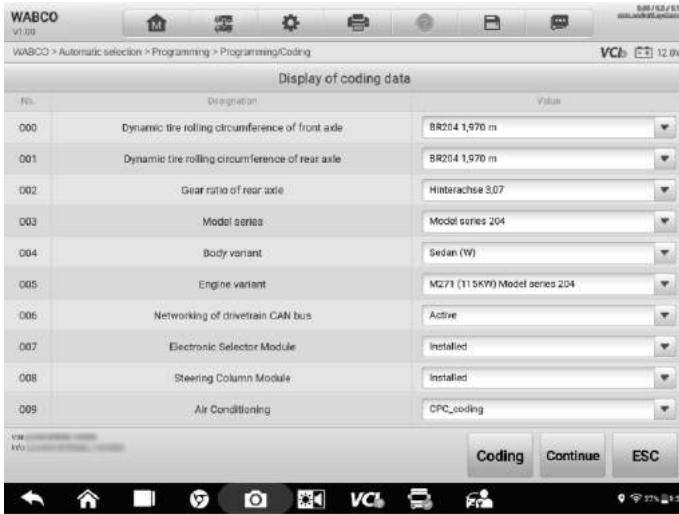

Figure 4-25 Sample Coding Screen

1. All available systems for coding are displayed on the left side, and the coding data or value on the right side.
2. The bottom of the main section displays the function buttons that enable you to manipulate the operation.

Check the vehicle condition and the coding information carefully. Use the function button to edit codes for the corresponding components. Tap **Send** when you finish editing all items. When the operation is completed, an execution status message such as Completed, Finished or Successful, may appear.

Tap the **ESC** button to exit the function.

4.10.2 Reprogramming

Before reprogramming begins

- Tablet must be connected to a stable Wi-Fi network.
- Tablet must be connected to VCI by USB.
- Tablet battery must be fully charged during module programming. Connect tablet to a charger if needed.

- Attach battery maintainer to vehicle battery to ensure a steady voltage is maintained throughout programming. Voltage requirements differ by vehicle manufacturer. Consult vehicle manufacturer recommendations prior to programming a module.
- Do not quit the application during a module programming as the process may fail and may also result in permanent damage to the module.

Typical reprogramming operations require you to input and validate the VIN number first. Tap the input box and enter the correct number. The programming interface then appears.

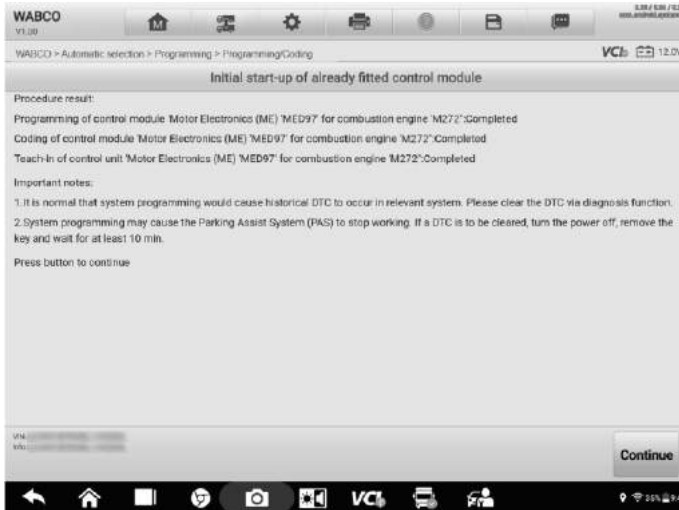

Figure 4-26 Sample Reprogramming Operation Screen

The main section of the reprogramming interface offers information about the hardware, the current software version and the newest software versions to be programmed into the control units.

A series of on-screen operational instructions will display to guide you through the programming procedure.

Carefully read the on-screen information and follow the instructions to execute the programming procedure.

4.10.3 Re-flash Errors

IMPORTANT

When reprogramming onboard, always make sure the vehicle battery is fully charged and in good working condition. During reprogramming, the operation may fail if voltage falls below the proper operation voltage. Sometimes a failed operation can be recovered, but the failed reprogramming can also ruin the control module. We recommend connecting an external battery maintainer to the vehicle to ensure a steady voltage is maintained throughout

programming. The required voltage differs by vehicle manufacturer. Consult vehicle manufacturer for correct voltage to be maintained.

Occasionally a flash update procedure may not be completed properly. Common causes of flash errors include poor cable connections between the tablet, VCI, and vehicle, the vehicle ignition being switched off before the flash procedure is completed, or low vehicle battery voltage.

If the process quits, recheck all cable connections to assure good communications and initialize the flash procedure. The programming procedure will automatically repeat if the previous operation does not succeed.

4.11 Generic OBDII Operations

The OBDII/EOBD vehicle diagnosis option offers a quick way to check for DTCs, isolate the cause of an illuminated malfunction indicator lamp (MIL), check monitor status prior to emissions certification testing, verify repairs, and perform other emissions-related services. The OBDII direct access option is also used for testing OBDII/EOBD-compliant vehicles that are not included in the diagnostics database. Diagnostics toolbar buttons at the top of the screen are available for specific vehicle diagnostics. See [Table 4-2 Diagnostics Toolbar Buttons](#) for details.

4.11.1 General Procedure

➤ To access the OBDII/EOBD diagnostics functions

1. Tap the **Diagnostics** button in the MaxiSys Job Menu. The Vehicle Menu appears.
2. Tap the **HD OBD** button. There are two options to establish communication with the vehicle.
 - **Auto Scan** — select to establish communication using each protocol in order to determine which one the vehicle is using.
 - **Protocol** — select to open a submenu of various protocols. A communication protocol is a standardized way of data communication between an ECM and a diagnostics tool. Global OBD may use several different communication protocols.
3. Select a specific protocol if the **Protocol** option is selected. Wait for the OBDII Diagnostic Menu to appear.



Figure 4-27 Sample OBDII Diagnostic Menu

4. Select a function to continue.

- DTC & FFD
- I/M Readiness
- Live Data
- O₂ Sensor Monitor
- On-Board Monitor
- Component Test
- Vehicle Information
- Vehicle Status

NOTE

Supported functions may vary by vehicle.

4.11.2 Function Descriptions

This section describes various functions of each diagnostics option.

4.11.2.1 DTC & FFD

When this function is selected, the screen displays a list of Current Codes and Pending Codes. When the Freeze Frame data of certain DTCs are available for viewing, a

snowflake button will display on the right side of the DTC item. The Erase Codes function can be applied by tapping the function button at the bottom of the screen.

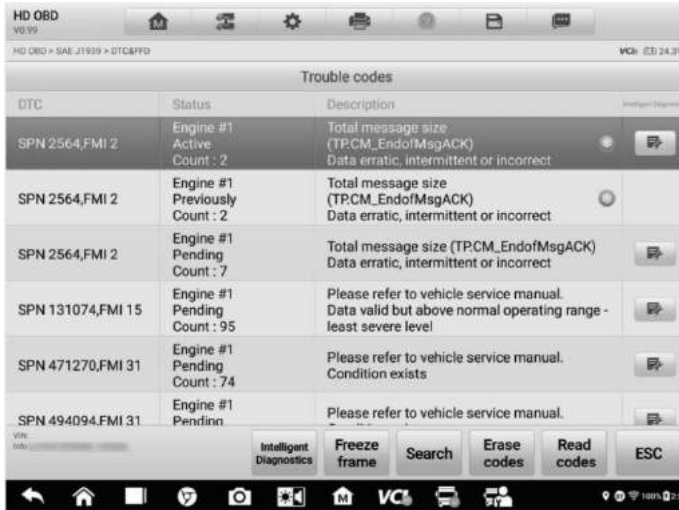

Figure 4-28 Sample DTC & FFD Screen

- **Current Codes**

Current codes are emission-related DTCs from the ECU of the vehicle. OBDII/EOBD Codes are prioritized according to their emission severity, with higher-priority codes overwriting lower-priority ones. The priority of the code determines the illumination of the Malfunction Indicator Light (MIL) and the codes erase procedure. Manufacturers rank codes differently, so DTCs may vary by vehicle.

- **Pending Codes**

These are codes whose storing conditions have been met during the last drive cycle, but need to be met on two or more consecutive drive cycles before the DTC stored. The purpose of displaying pending codes is to assist the service technician after a vehicle repair when diagnostic information is cleared, by reporting test results after a single driving cycle.

- If a test fails during the driving cycle, the DTC associated is reported. If the pending fault does not occur again within 40 to 80 warm-up cycles, the fault is automatically cleared from memory.
- Test results reported do not necessarily indicate a faulty component or system. If test results indicate another failure after additional driving, a DTC is stored to indicate a faulty component or system.

- **Freeze Frame**

In most cases the stored frame is the last DTC reported. Certain DTCs — those that have a greater impact on vehicle emission — have a higher priority. In these cases, DTC of the highest priority is the one for which the freeze frame records are retained. Freeze frame data includes a “snapshot” of critical parameter values at the time the DTC is stored.

- **Erase Codes**

This option is used to clear all emission-related diagnostics data including DTCs, freeze frame data and specific manufacturer-enhanced data from the vehicle ECU. This option resets the I/M Readiness Monitor Status for all vehicle monitors to Not Ready or Not Complete status.

A confirmation screen displays when the clear codes option is selected to prevent accidental loss of data. Tap **Yes** on the confirmation screen to continue, or **No** to exit.

4.11.2.2 I/M Readiness

This function is used to check the readiness of the monitoring system. It is an excellent function to use prior to having a vehicle inspected for state emissions compliance. Selecting I/M Readiness opens a submenu with two choices:

- Since DTCs Cleared — displays the status of monitors since the last time the DTCs were erased.
- This Driving Cycle — displays the status of monitors since the beginning of the current drive cycle.

4.11.2.3 Live Data

This function enables the display of real-time PID data from the ECU. Displayed data includes analog and digital input and output, and system status information broadcast in the vehicle data stream.

Live data can be displayed in various modes, see [Live Data](#) for detailed information.

4.11.2.4 O₂ Sensor Monitor

This function allows retrieval and review of recent O₂ sensor monitor test results stored on the vehicle on-board computer.

The O₂ Sensor Monitor test function is not supported by vehicles that communicate using a controller area network (CAN). For O₂ Sensor Monitor tests results of CAN-equipped vehicles, refer to [On-Board Monitor](#).

4.11.2.5 On-Board Monitor

This function allows you to view the results of On-Board Monitor tests. The tests are useful after the service when a vehicle control module memory is already erased.

4.11.2.6 Component Test

This function enables dual-directional control of the ECU so that the diagnostics tool can transmit control commands to operate the vehicle systems. This function is useful in determining how well the ECU responds to a command.

4.11.2.7 Vehicle Information

This function enables the display of the vehicle identification number (VIN), calibration identification number, calibration verification number (CVN), and other information of the test vehicle.

4.11.2.8 Vehicle Status

This function checks the current condition of the vehicle, such as the communication protocols of OBDII modules, number of fault codes, and status of the Malfunction Indicator Light (MIL).

4.12 Diagnostics Report

4.12.1 Pre-Scan and Post-Scan

➤ To perform the pre-scan and post-scan functions

1. Auto scan the Vehicle — the Auto VID function can automatically identify the vehicle and its equipped systems. All available modules in all systems will be scanned automatically. Codes and their details will be listed.
2. Print Pre-scan Report — vehicle images can be taken with the tablet and attached to SCAN report. The report file can be generated and submitted. The report can be customized with shop and vehicle information.
3. Repair Vehicle — creates efficient repair plan from the start.
4. Auto scan Repaired Vehicle — ensures no new faults were created during repair and no DTCs are present at completion.
5. Print Post-scan Report — proves all DTCs on Pre-SCAN report are repaired.

4.12.2 Diagnostic Report PDF

The diagnostic report can be reviewed, saved, and printed in multiple applications of the platform.

a) Via the **History** function:

- Enter the Diagnosis main page, and tap **History** in the Top Toolbar.

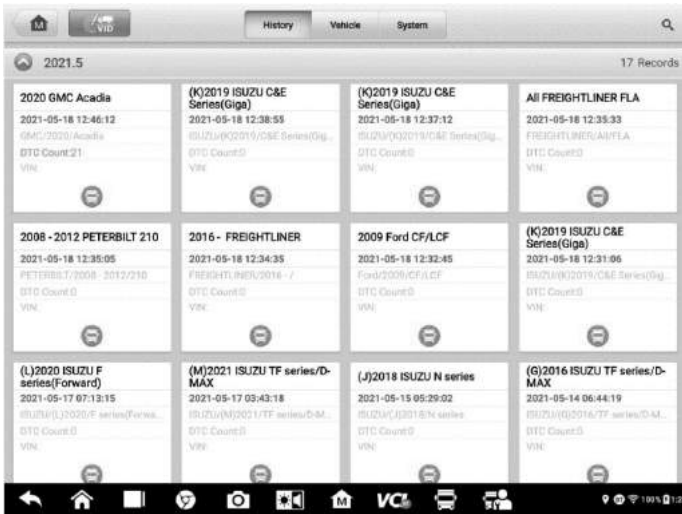

Figure 4-29 Sample History Screen

- Select a history record and tap the **...** button on the upper-right corner to view the PDF document, print, email or delete the test record.

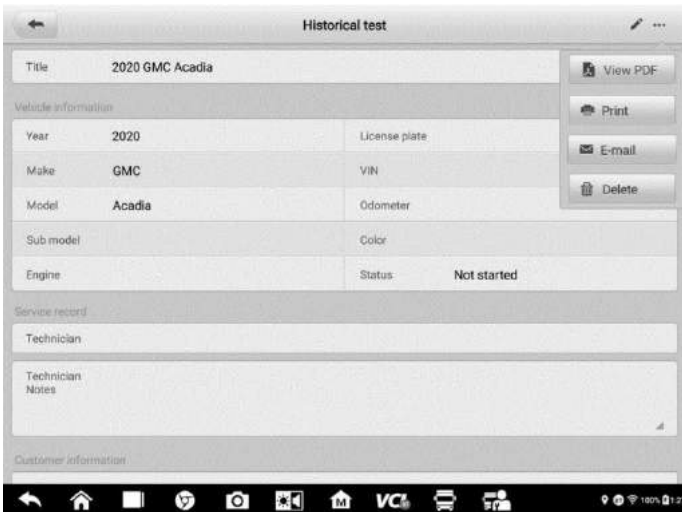

Figure 4-30 Sample Test Record Screen

b) Via the **Auto Scan** function:

- Enter the Auto Scan page and tap **Fault Scan** at the bottom of the screen.

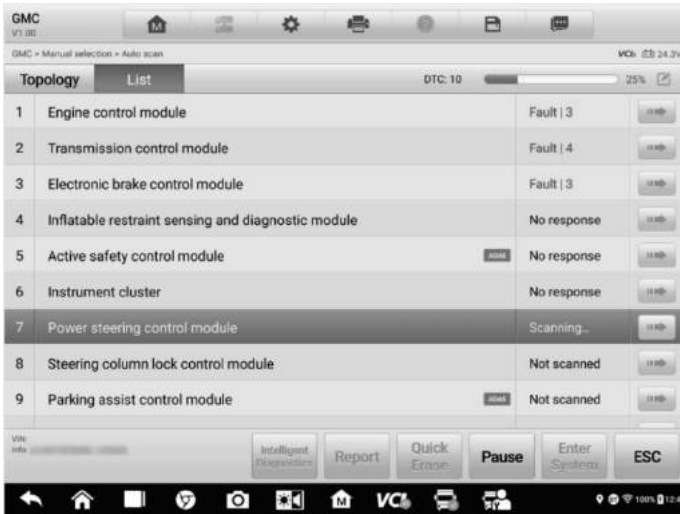

Figure 4-31 Sample Auto Scan Screen 1

- When the system scan is completed, tap **Report** in the Function Button Bar at the bottom of the screen.



Figure 4-32 Sample Auto Scan Screen 2

- Tap the  button in the Diagnostics Toolbar and select **Save all data** to save the PDF document or select **Save this page** to save the screenshot of the current page.



Figure 4-33 Sample Auto Scan Screen 3

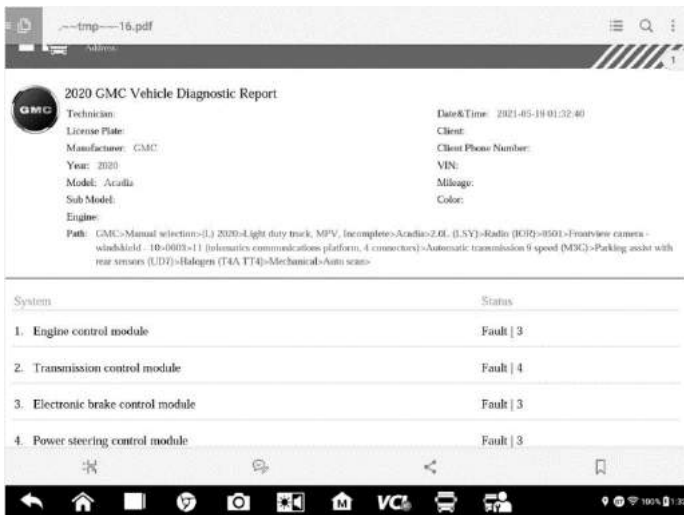

Figure 4-34 Sample PDF Document Screen

c) Via the functions on the Navigation Bar:

- The diagnostic report can also be viewed from such diagnostics function screens including Auto Scan, Read Codes, Live Data, and Active Test screens. Tap the  button in the Diagnostics Toolbar, and select **Save all data** to save the PDF document or select **Save this page** to save a screenshot of the current page.



Figure 4-35 Sample Read Codes Screen

4.13 Exit Diagnostics

The Diagnostics application operates while communication between the tablet and the vehicle is still active. It is important to properly exit from the diagnostics operation interface to stop all communications with the vehicle before closing the Diagnostics application.

NOTE

Damage to the vehicle electronic control module (ECM) may occur if communication is disrupted. Ensure all forms of communication links such as data cable, USB cable, and wireless or wired network, are properly connected throughout the test. Exit all interfaces before disconnecting the test cable and power supply.

➤ **To exit the Diagnostics application**

1. On an active diagnostic screen, tap the **Back** or **ESC** button to exit a diagnostic session, or tap **Vehicle Swap** button in the diagnostics toolbar to return to the Vehicle Menu screen.
2. On the **Vehicle Menu** screen, tap the **Home** button in the top toolbar, or tap the **Back** button in the navigation bar at the bottom of the screen, or tap the **Home** button in the diagnostics toolbar to exit the application directly and return to the MaxiSys Job Menu.

Now, the Diagnostics application is no longer communicating with the vehicle and it is safe to open other MaxiSys applications or exit the MaxiSys Diagnostics System and return to the Home screen.

5 Intelligent Diagnostics

Intelligent Diagnostics is a specific fault code analysis function, with which you can access the most comprehensive and the latest Vehicle System and Detected DTC(s), Technical Service Bulletin, and DTC Analysis. It has been drawn from real shop repair orders and records and with input from experienced industry professionals.

Intelligent Diagnostics adopts the scientific data cloud computing technology to match the specific fault code with the exact vehicle model. And the data has been verified by automotive maintenance professionals.

The following are main parts of the code data contained in Intelligent Diagnostics:

1. Vehicle System and Detected DTCs
2. Technical Service Bulletin (OEM Information)
3. DTC Analysis

NOTE

Before launching the Intelligent Diagnostics function, please ensure the network is connected successfully.

5.1 Accessing Intelligent Diagnostics

5.1.1 Auto Scan

Before launching Intelligent Diagnostics, please ensure that vehicle communication has been established. Connect the MaxiSys MS909CV Diagnostic tablet to the test vehicle through the VCI device. For detailed instructions to establish vehicle communication with the MaxiSys tablet, see [Establish Vehicle Communication](#).

Once communication is established, enter the **Diagnostics** application and select a vehicle model. After a vehicle model is selected, tap **Auto Scan** from the **Main menu**. The **System list** screen will display. For detailed instructions on using the Auto Scan function, see [Auto Scan](#).

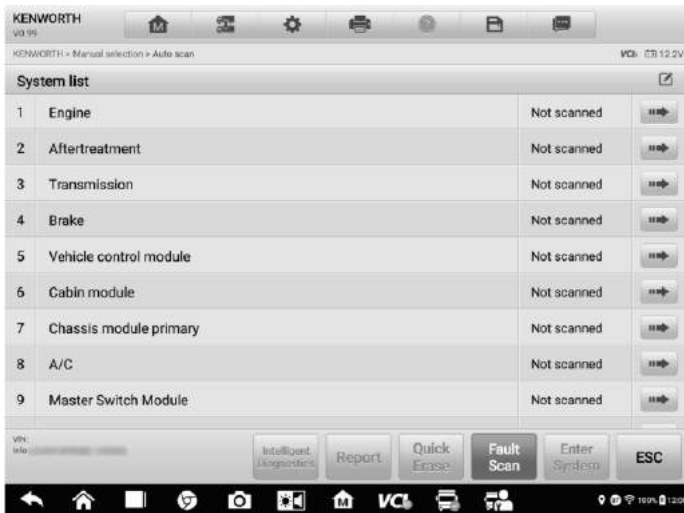

Figure 5-1 Sample System List Screen

The topology map, which displays relations among different systems, is available on certain vehicles, including Kenworth, Peterbilt, Chevrolet and more.

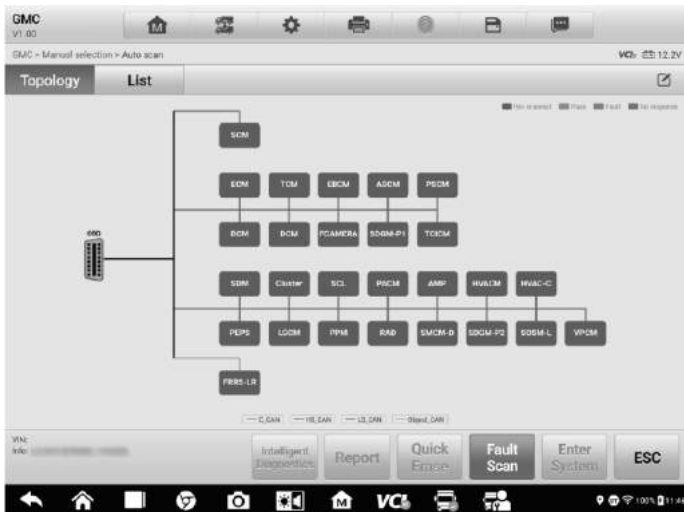

Figure 5-2 Sample Topology Display Screen

Select the **List** tab to display the vehicle systems in a list.

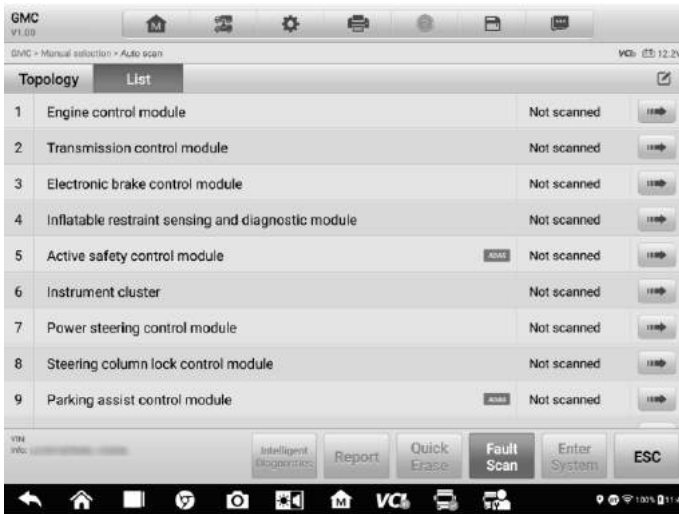

Figure 5-3 Sample List Screen

5.1.2 Scan System Faults

Once the vehicle system listing or Topology mapping is completed, tap the **Fault Scan** button at the bottom of the **System list**, **Topology** or **List** screen to identify the faults in the vehicle systems.

- 1) On the **System list** screen, tap the **Fault Scan** button at the bottom. After scanning, a system with identified faults will display in red, with the number of faults displayed on the right. The number of total faults will display on the top.

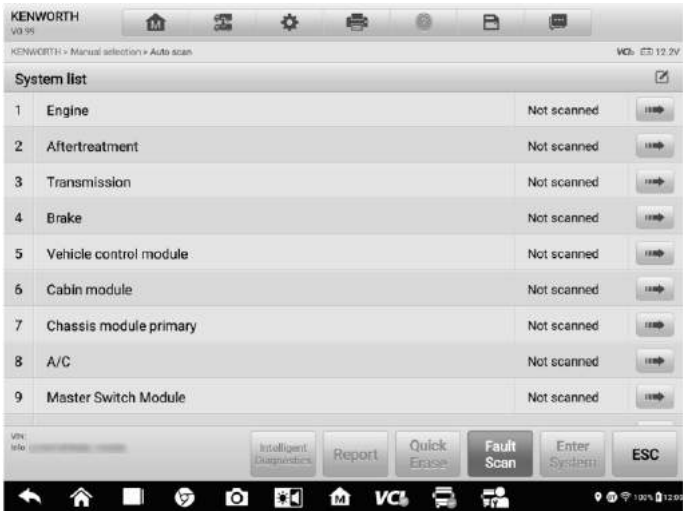

Figure 5-4 Sample Fault Scan on System List Screen 1

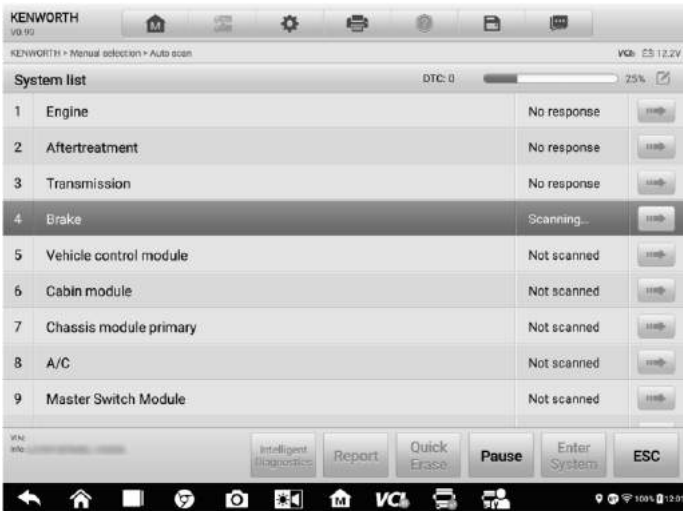

Figure 5-5 Sample Fault Scan on System List Screen 2

- 2) On the **Topology** screen, a system with identified faults will display in orange, with the number of faults displayed on the upper-right corner of the system icon. The number of total faults will display on the top.

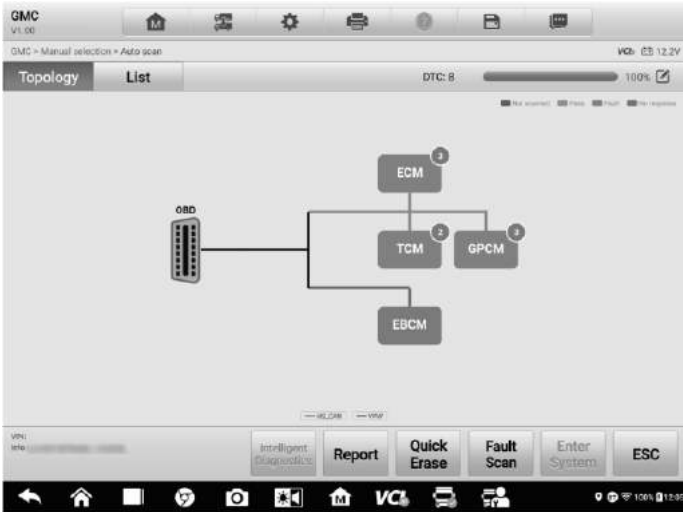

Figure 5-6 Sample Fault Scan on Topology Screen

- 3) On the **List** screen, a system with identified faults will also display in red, with the number of faults on the right. The number of total faults will display on the top.

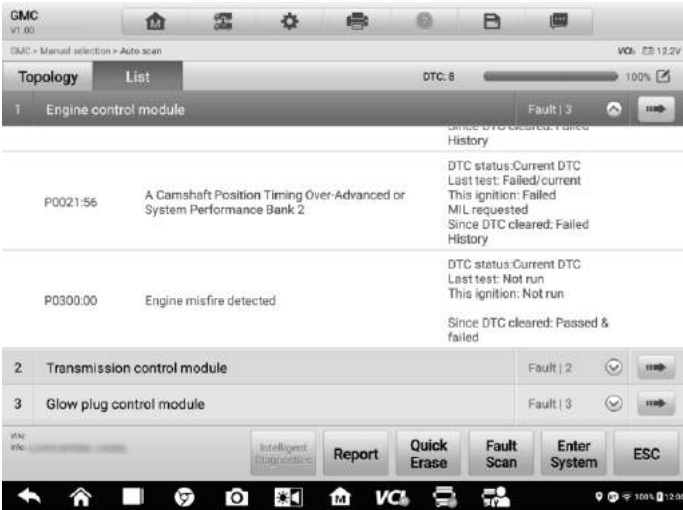



Figure 5-7 Sample Fault Scan on List Screen

After scanning system faults, there are two methods to access the Intelligent Diagnostics screen:

- Access via the **Intelligent Diagnostics** button  to view code-related information of all DTCs for the whole vehicle.

- Access via the **Intelligent Diagnostics** icon  to view code-related information of a specific DTC.

5.1.3 Access via Intelligent Diagnostics Button

After all the faults of the vehicle systems are scanned, tap the **Intelligent diagnostics** button on the bottom of the screen to directly enter the Intelligent Diagnostics screen.

Entering the Intelligent Diagnostics screen, you can find the TSB and DTC analysis information of **All DTCs** for all the systems that have been scanned. For detailed operation instructions, please refer to the [Intelligent Diagnostics Operation](#) for details.

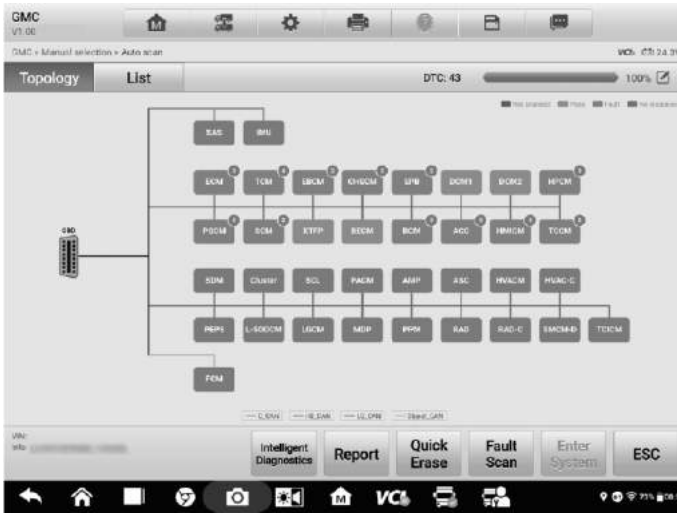

Figure 5-8 Sample Intelligent Diagnostics Button Screen

5.1.4 Access via Intelligent Diagnostics Icon

You can also use the **Intelligent Diagnostics** icon to enter the Intelligent Diagnostics function to get detailed fault repair instructions of a specific DTC.

The details of the detected faults, including the fault code, fault description and status, will be displayed under the system name or module. If the Intelligent Diagnostics function is available for this vehicle, the **Intelligent Diagnostics** icon will display on the right.

On the **List** screen, tap the **Intelligent Diagnostics** icon on the right side to enter the Intelligent Diagnostics screen directly.

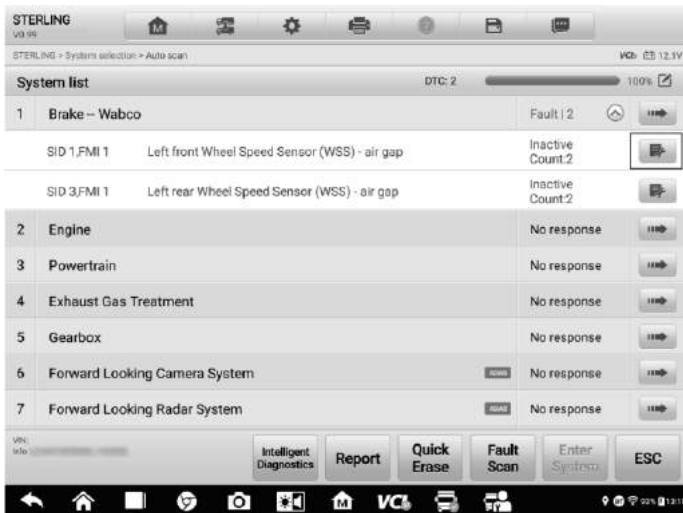

Figure 5-9 Sample Intelligent Diagnostics Icon Screen 1

On the **Topology** screen, once the system scan is completed, tap a system icon (displays in orange if faults are detected) to display complete system name with the Intelligent Diagnostics icon shown below. Tap the **Intelligent Diagnostics** icon to enter the Intelligent Diagnostics screen directly.

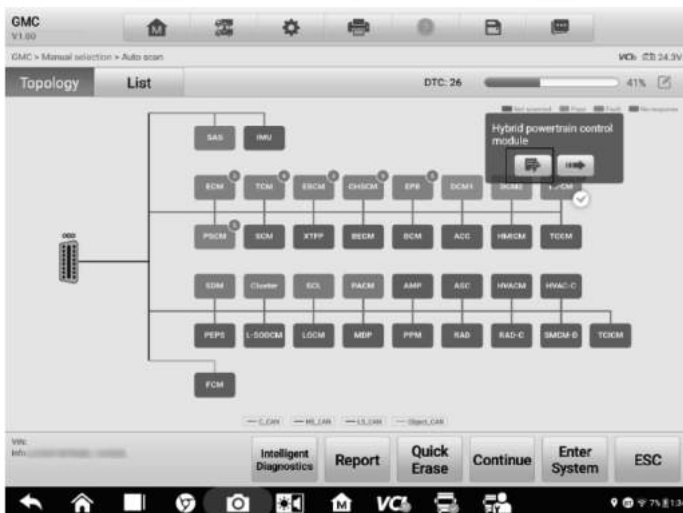



Figure 5-10 Sample Intelligent Diagnostics Icon Screen 2

When entering a specific system by tapping the arrow icon , you can also access the Intelligent Diagnostic screen if the Intelligent Diagnostics function is available for this vehicle.

1. On the System list, Topology or List screen, tap the arrow icon  to enter a system, the Function menu will display. Available functions vary by vehicle.

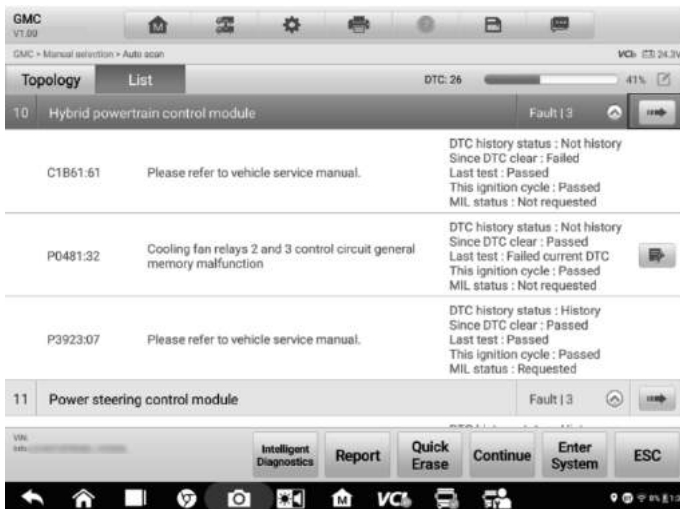

Figure 5-11 Sample Entering System Icon Screen (List)

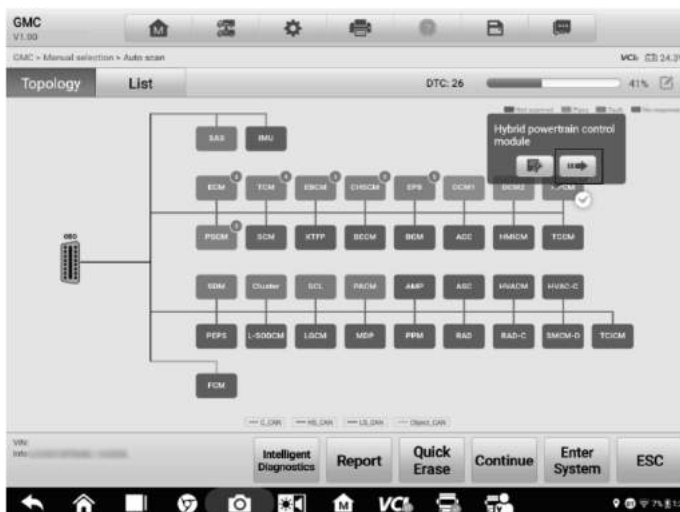

Figure 5-12 Sample Entering System Icon Screen (Topology)

2. Select **Trouble codes** from the Function menu screen and the trouble codes screen will display.



Figure 5-13 Sample Function Menu Screen

3. Tap the **Intelligent Diagnostics icon**  to the right of the DTC description, or select a specific DTC from the DTC list, and then tap the **Intelligent Diagnostics** button at the bottom of the screen.



Figure 5-14 Sample Trouble Codes Screen

5.2 Intelligent Diagnostics Operation

Intelligent Diagnostics is an important and powerful function of MaxiSys MS909CV. It provides substantial information for Vehicle System and Detected DTCs, Technical Service Bulletin, and DTC Analysis to help you repair detected faults.

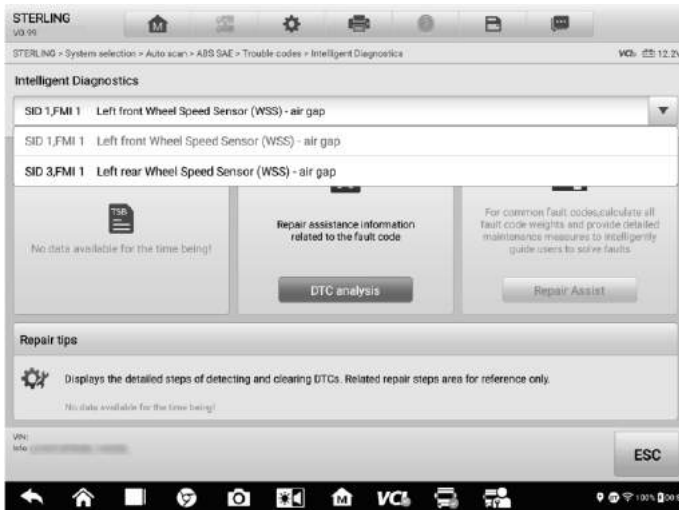

Figure 5-15 Sample Intelligent Diagnostics Layout

The **Intelligent Diagnostics** function consists of the following sections:

1. **Vehicle System and Detected DTCs** — displays the name of the vehicle system(s) and the detected DTCs.
2. **Technical Service Bulletin** — contains DTC-related recalls, TSB, and OEM campaigns.
3. **DTC Analysis** — provides repair assistance information related to the fault code.

5.2.1 Vehicle System and Detected DTC(s)

This section displays the scanned vehicle systems that contain faults. Tap the drop-down menu to view comprehensive information of ALL systems or switch to different fault codes for details.

Tap the arrow button on the right to display a drop-down list of all systems along with specific DTCs. Touch and slide up or down on the screen to review all codes in the list. Select ALL systems or select a DTC to view the corresponding Intelligent Diagnostics information.



Figure 5-16 Sample Vehicle System and Detected DTC(s) Screen

5.2.2 Technical Service Bulletin (OEM Information)

The Technical Service Bulletin function matches the selected fault code with relevant vehicle manufacturer TSBs. All TSBs related to the selected DTC are listed in the TSB display window. Select a TSB to open the TSB page and view the TSB in details.



Figure 5-17 Sample TSB Screen

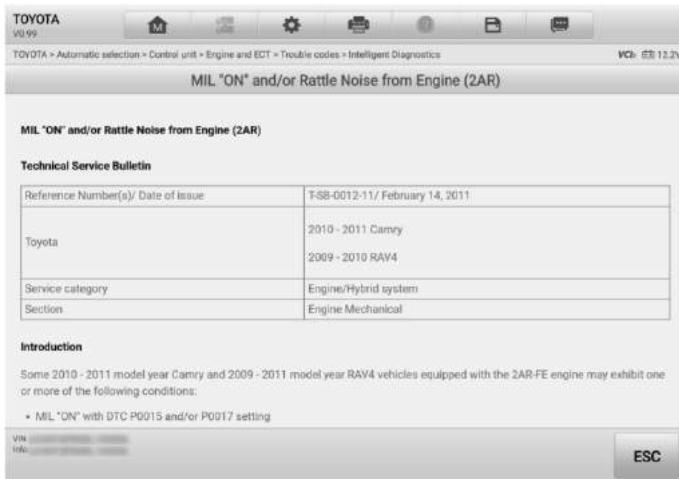

Figure 5-18 Sample TSB in Details

5.2.3 DTC Analysis

On the **Intelligent Diagnostic** screen, the DTC Analysis contains repair assistance and information related to the fault codes, including the fault description, condition, fault influence, possible cause, and possible solution. The repair assistance information vary by vehicle.



Figure 5-19 Sample DTC Analysis Screen

6 Service

The **Service** section is specially designed to provide quick access to the vehicle systems for various scheduled service and maintenance tasks. The typical service operation screen is a series of menu-driven commands. Follow the on-screen instructions to select appropriate options, enter values or data, and perform necessary actions. The application will display detailed instructions to complete selected service operations.

After entering each special function, the screen will display two application choices: **Diagnosis** and **Hot Functions**. The **Diagnosis** enables the reading and clearing of codes, which is sometimes necessary after completing certain special functions. **Hot Functions** consists of sub functions of the selected special functions.

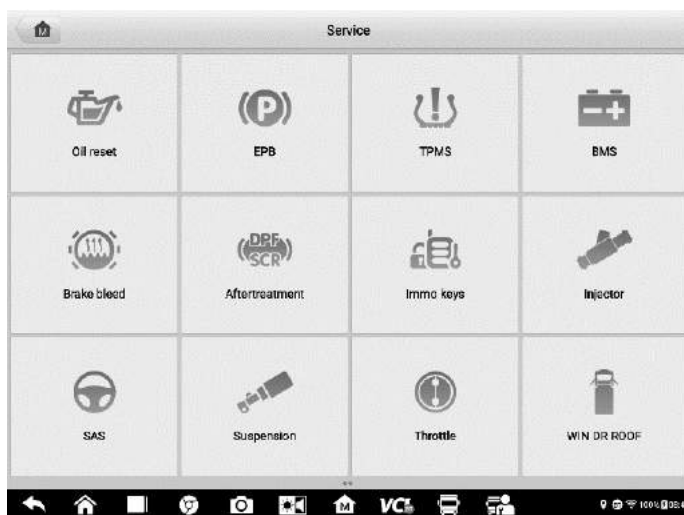

Figure 6-1 Sample Service Menu

Several most commonly used services are described in this chapter.

6.1 Oil Reset Service

Perform reset for the Engine Oil Life system, which calculates an optimal oil life change interval depending on the vehicle driving conditions and climate. The Oil Life Reminder must be reset each time the oil is changed, so the system can calculate when the next oil change is required.

NOTE

1. Always reset the engine oil life to 100% after every oil change.

2. All required work must be carried out before the service indicators are reset. Failure to do so may result in incorrect service values and cause DTCs to be stored by the relevant control module.
 3. For some vehicles, the scan tool can reset additional service lights such as maintenance cycle and service interval. On BMW vehicles for example, service resets include engine oil, spark plugs, front/rear brakes, coolant, particle filter, brake fluid, micro filter, vehicle inspection, exhaust emission inspection and vehicle checks.
-

6.2 Aftertreatment Service

The Aftertreatment function manages DPF regeneration, DPF component replacement teach-in and DPF teach-in after replacing the engine control unit.

The ECM monitors driving style and selects a suitable time to employ regeneration. Cars driven a lot at idling speed and low load will attempt to regenerate earlier than cars often driven with higher load and speed. For regeneration to take place, a prolonged high exhaust temperature must be obtained.

In the event of the car being driven in such a way that regeneration is not possible, i.e., frequent short journeys, a diagnostic trouble code will eventually be registered in addition to the DPF light and “Check Engine” indicators displaying. A service regeneration can be requested in the workshop using the diagnostics tool.

Before performing a forced DPF regeneration using the tool, check the following items:

- The fuel light is not on.
- No DPF-relevant faults are stored in system.
- The vehicle has the specified engine oil.
- The oil for diesel is not contaminated.

! IMPORTANT

Before diagnosing the problem vehicle and attempting to perform an emergency regeneration, it is important to obtain a full diagnostic log and read out relevant measured value blocks.

🔧 NOTE

1. The DPF will not regenerate if the engine management light is on, or there is a faulty EGR valve.
2. The ECU must be re-adapted when replacing the DPF and when topping up the fuel additive Eolys.
3. If the vehicle needs to be driven in order to perform a DPF service, a second person is required for the function. One person should drive the vehicle while the other person observes the screen on the tool. Do not attempt to drive and observe the scan

tool at the same time. This is dangerous and puts your life and the lives of other motorists and pedestrians at risk.

6.3 Limit Service

This function is usually used to change the maximum speed limit of a vehicle (some vehicles are manufactured with a maximum speed limit set by the manufacturer).

6.4 Injector Service

This function is usually used to set the compensation code for the new injector assembly or the injectors to the Engine ECU after replacement.

6.5 Speed & PTO Service

The Cylinder function allows a technician to carry out cylinder bank cutout test, cylinder cutout test, cylinder performance test, and single bank cutout test to troubleshoot cylinder misfires. The sub-functions may vary by test vehicle.

6.6 VGT Learn Service

Turbo matching — this function is used for turbine removal and recalibration.

7 Battery Test

Battery Test conducts battery and cranking/charging systems analysis and enables technicians to view the health status of the vehicle's battery and electrical system. Functions include in-vehicle test and out-vehicle test.



Figure 7-1 Sample Battery Test Screen

7.1 Test Preparation

7.1.1 Inspect the Battery

Before starting a test, observe the battery for:

- Cracking, buckling or leaking (If you see any of these defects, replace the battery.)
- Corroded, loose or damaged cables and connections (Repair or replace as needed.)

Corrosion on the battery terminals, and dirt or acid on the case top (Clean the case and terminals using a wire brush and a mixture of water and baking soda.)

7.1.2 Connect the Battery Tester

➤ **To pair the with the MaxiSys MS909CV tablet**

1. Press and hold the **Power** Button to turn on the MS909CV. Ensure that the unit is sufficiently charged before use.

2. Enable **Bluetooth** on the MS909CV by tapping **VCI Manager > BAS BT**, and the tablet automatically scans for an available tester for Bluetooth pairing. The device name will appear as “Maxi” suffixed with a serial number.
3. Check the serial number of your MaxiBAS B200 series tester and select the desired device for pairing.
4. When paired successfully, the connection status will read as “Connected” and the Status LED will light solid blue.

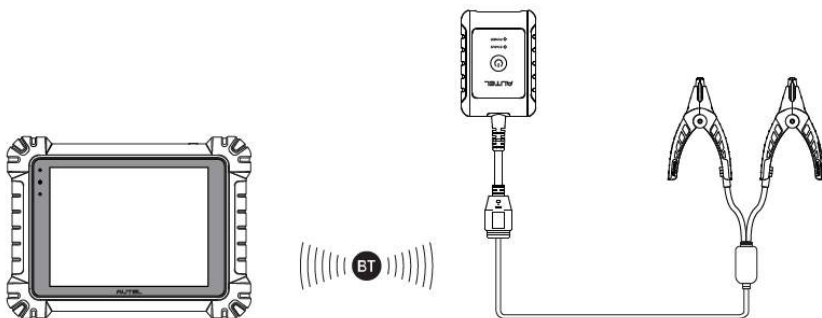

➤ **To connect to a battery**

Connect the red clamp to the positive (+) terminal and the black clamp to the negative (-) terminal of the battery.

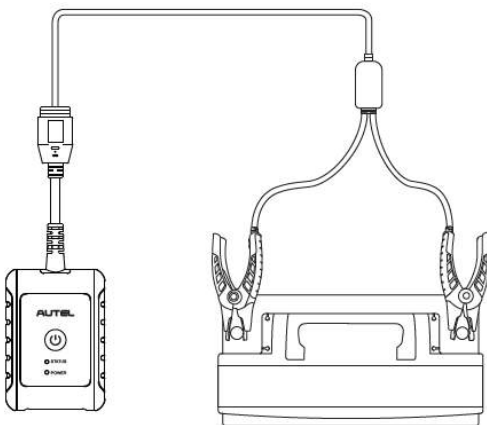

7.2 In-vehicle Test

In-vehicle Test is used for testing batteries that are installed in a vehicle. An in-vehicle test includes Battery Test, Starter Test, and Generator Test. These tests help determine the health status of the battery, the starter, and the generator.

! IMPORTANT

A disclaimer page will appear when accessing any function on the **Home** screen for the first time. Please read the end user agreement and Tap **Accept** to continue. If you tap **Decline**, you will not be able to use the features properly.

Prior to testing any battery, ensure that the B200 series tester is paired with the tablet via Bluetooth.

7.2.1 Start the test

➤ To start the battery test

1. Select **In-vehicle Test**.
2. Choose your desired vehicle type from Truck Group31 or Commercial 4D/8D (for example).

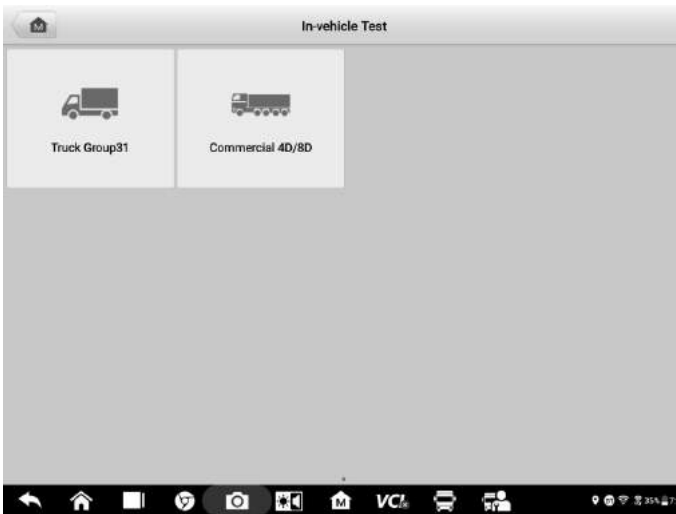

Figure 7-2 Sample In-vehicle Test Screen

3. Confirm your battery information, including voltage, type, standard, and capacity. Tap **Next** to continue in-vehicle test functions.

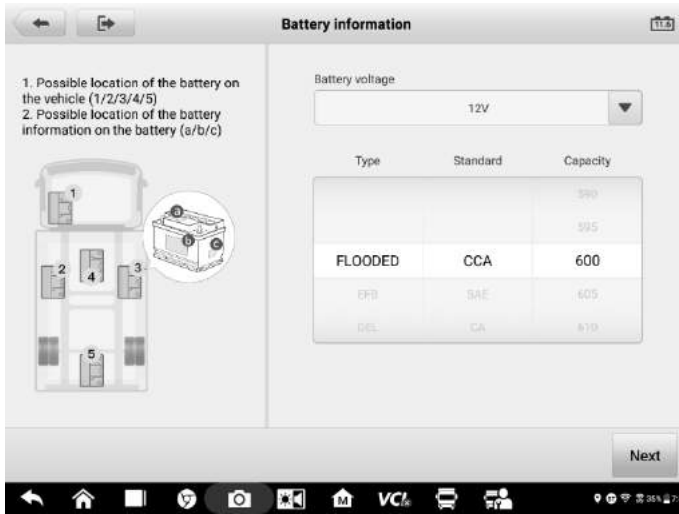







Figure 7-3 Sample Battery information Screen

Please refer to the table below for a list of buttons that may appear when accessing the functions:

Table 7-1 Top Toolbar Buttons

Battery Connection		The value on the icon indicates the real-time voltage of the tested battery. In the battery test, the button will turn green if the battery is good; otherwise, it will turn red.
Next		Tap to proceed.
Home		Returns to the MaxiSys Job Menu.
Back		Returns to the previous screen.
Exit		Returns to the Job Menu.

7.2.2 Battery Test

1. Follow the on-screen instructions. Check the boxes once all required tasks are completed, and tap **Start Testing**.

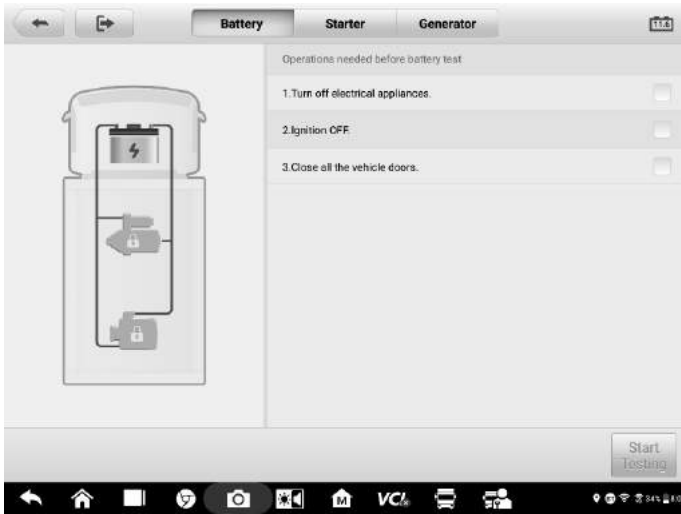

Figure 7-4 Sample Battery Screen

2. Wait until the test is completed. The test results will be displayed on the tool.



Figure 7-5 Sample Battery Test Results Screen

Battery Test Results

The battery test results include a color-coded results summary, a list of test data, and repair tips.

Table 7-2 Test Results

Result	Repair Tip
Good Battery	Battery is good.
Good & Recharge	Battery is good but insufficiently charged. Recharge the battery.
Charge & Retest	Battery requires charge to determine its condition.
Bad Cell	Replace the battery.
Replace Battery	Replace the battery.

NOTE

Please always complete the battery test before you proceed to the starter and generator tests.

7.2.3 Starter Test

Follow the on-screen instructions to complete the test. Start the engine and let it idle. The test results will appear as follows:

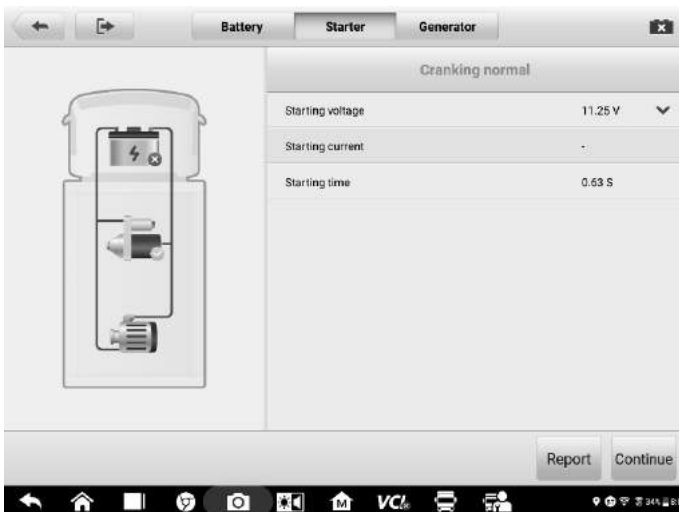

Figure 7-6 Sample Starter Test Result Screen

Table 7-3 Starter Test Results

Result	Description
Cranking Normal	The starter is good.
Current Too Low	Low momentary discharge capacity.
Voltage Too Low	Low battery storage capacity.
Not Started	The starter is not detected for starting.

7.2.4 Generator Test

Follow the on-screen instructions to complete the test. The test results will appear as follows:

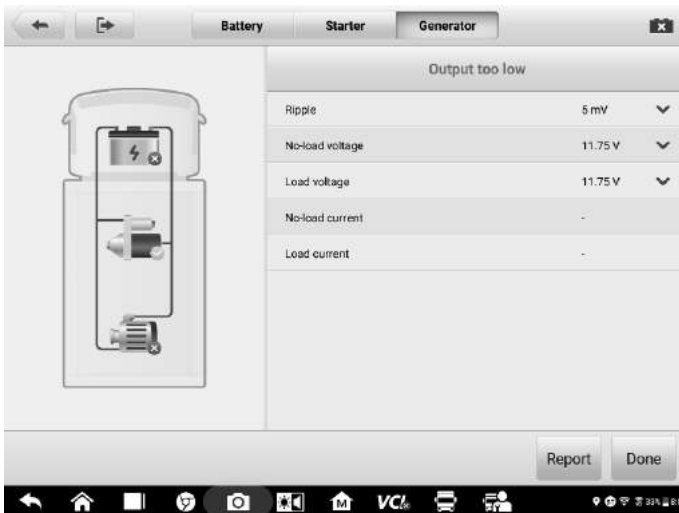

Figure 7-7 Sample Generator Test Results Screen

Table 7-4 Generator Test Results

Result	Description
Charging Normal	The generator is functioning normally.
Output Too Low	<ul style="list-style-type: none"> ● The belt linking the starter and the generator is loose; ● The cable linking the starter and battery is loose or corroded.
Output Too High	<ul style="list-style-type: none"> ● The generator is not properly connected to the ground; ● The voltage adjuster is broken and needs replacement.
Ripple Too Large	The commutation diode is broken.
No Output	<ul style="list-style-type: none"> ● The cable is loose; ● Some vehicles with power management systems do not provide path for charging due to the sufficient load capacity of the battery; ● The generator or the voltage adjuster is broken and needs replacement.

NOTE

To measure the current, connect the current clamp. Tap the **Settings** button on the main menu to enter the application. Swipe the **Current Clamp** toggle to turn it **ON**.

7.3 Out-vehicle Test

Out-vehicle Test is used to test the conditions of batteries that are not connected to a vehicle. This function aims to check the health status of the battery only.

7.3.1 Test Procedure

➤ **To start the out-vehicle test**

1. Connect the tester clamps to the battery terminals.
2. Select the appropriate battery type, rating standard, and CCA value. Tap **Start Testing** to start the test.

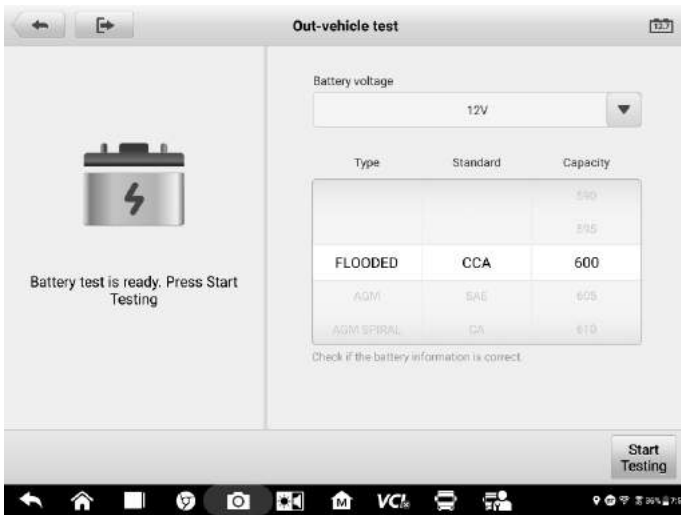

Figure 7-8 Sample Out-vehicle Test Screen

3. The test results will display in a few seconds.



Figure 7-9 Sample Out-vehicle Test Results Screen

7.3.2 Test Results

Icons are color-coded to indicate status.

Table 7-5 Out-vehicle Test Results

Result	Description
Good Battery	Battery meets required standards.
Good & Recharge	Battery is good, but low on charge. Fully charge the battery. Check for causes of low charge.
Charge & Retest	Battery requires charge to determine its condition.
Replace Battery	Battery fails to meet industry-accepted standards.
Bad Cell	Battery fails to meet industry-accepted standards.

8 Multimeter

The multimeter (sold separately) is a multi-function, multi-range measuring instrument. Connect the multimeter to the B200 device and access its features directly from the MaxiSys 909CV Home screen to perform basic functions including AC/DC voltage, resistance measurements, AC/DC current, diode, and connectivity tests. The test results are displayed in various formats for easy viewing.

8.1 Safety Information

Follow the instructions below to reduce the risk of injury from electric shock and prevent equipment damage.

- Use the multimeter only as specified in this manual.
- Do not apply more than the rated voltage between connectors or between any connector and ground.
- Do not input a value beyond the maximum range when measuring. Remember that the maximum range of this multimeter is 200V.
- To prevent injury or death, do not use the multimeter if it appears to be damaged in any way, and stop use immediately if you are concerned with any abnormal operations.
- To prevent injury or death, never ground yourself when taking electrical measurements. Isolate yourself from ground by using dry rubber insulating mats to cover all exposed/grounded metal. Ensure all clothing, including gloves, are dry. Stand on rubber mats when using the tool.
- Use the test leads or probes supplied with the product, or compatible terminals. Inspect the test leads or probes for damage before use.
- When using probes, keep fingers behind the finger guards on the probes.
- Use the supplied replacement fuses or specified replacement parts.
- Always consider electrical and electronic equipment to be energized (live). Never assume any equipment is de-energized.
- When making electrical connections, connect the common test lead before connecting the live test lead; when disconnecting, disconnect the live test lead before disconnecting the common test lead.
- When measuring current, turn off circuit power before connecting the multimeter to the circuit. Remember to place the multimeter in series with the circuit.
- After current measurement is finished, turn off the power to the circuit before removing the test leads and before reconnecting any disconnected wires or devices.
- Do not add voltage to the input terminal when measuring resistance.
- To avoid electric shock, turn off the power to the component before connecting.

- To prevent damage, always use and store your multimeter in appropriate environments.
- Do not use in wet or damp conditions or around explosive gas or vapor.
- Do not tamper with or disassemble the multimeter, connectors or accessories. Internal damage will affect performance.
- Before carrying out maintenance and cleaning of the multimeter, make sure the unit is NOT connected to a power source, vehicle or computer.
- When cleaning the multimeter, use a damp, soft cloth with mild detergent. Do not allow water to enter the multimeter casing.

8.2 Connecting the Multimeter

1. Power on the MS909CV and ensure that the MaxiBAS B200 series tester is paired with the tablet via Bluetooth (For more information, see [Connect the Battery Tester](#)). Tap the **Multimeter** button to enter the application.
2. Plug the red test lead into the red input of the multimeter, and the black test lead into the black input.

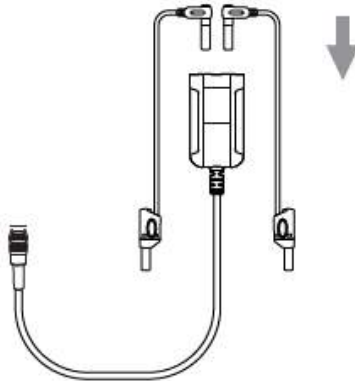

3. Connect the red alligator clip/red probe to the other end of the red test lead, and the black alligator clip/black probe to the black test lead.

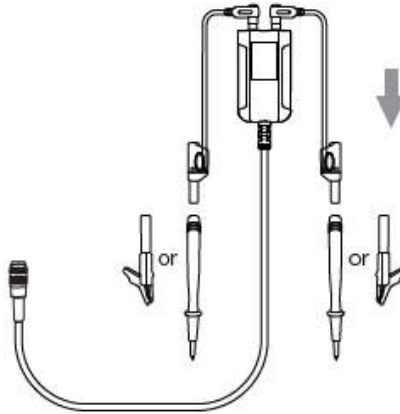

4. Connect the multimeter to the multimeter cable port of the MaxiBAS B200 Series Tester and tighten the connector of the multimeter.

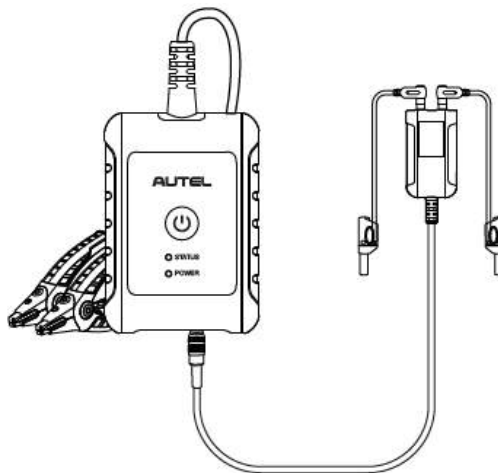

5. Now you can start to perform basic functions including AC/DC voltage, resistance measurements, AC/DC current, diode, and connectivity tests. Access the test results directly from the MaxiSys 909CV Home screen.

8.3 Screen Layout and Operations

Tap the **Multimeter** icon on the main menu to view the multimeter page.

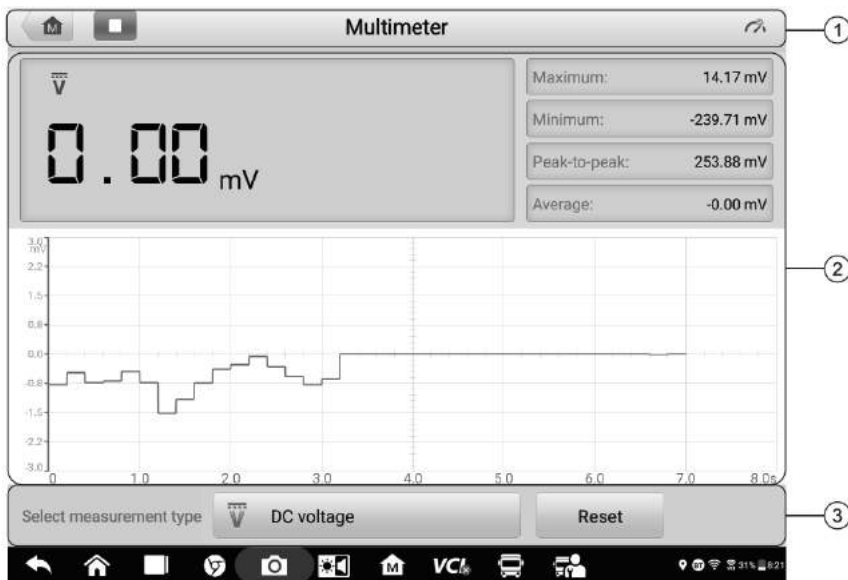

Figure 8-1 Sample Multimeter Home Screen

1. Upper Toolbar

Icon	Name	Description
	MaxiSys Home	Returns to MaxiSys Job Menu.
	Start/Stop Button	Starts or stops the multimeter device. Tap to start the multimeter; Tap to stop the multimeter.
	Multimeter status icon	Indicates the connection status with the battery tester. A green “√” mark means that the tester and the multimeter are connected; a red “x” means that the device and the tester are not connected.

2. Main view section







The main view section displays the digital readouts on the top and the waveform in the grid.

- **Current Value:** the current value can be the AC voltage, DC voltage, resistance, frequency, or duty cycle.
- **Maximum:** the recorded maximum value of the measurement.

- **Minimum:** the recorded minimum value of the measurement.
- **Peak-to-Peak:** the difference between the maximum and minimum values.
- **Average:** the average value of the measurements.
- **The waveform in the grid:** a coordinate grid with the X-axis representing the time duration and the Y-axis representing the amplitude level.

3. Lower Toolbar

- Tap  to select the measurement types you want:

Icon	Name	Description
	AC voltage	Measures the voltage in the electrical circuit.
	DC voltage	
	Resistance	Measures the resistance of the electrical circuit or the component.
	AC current	Measures current amperage by using the optional current clamp.
	DC current	
	Diode	Conducts a diode test of the electrical circuit.
	Connectivity	Determines whether a low impedance exists two points in the electrical circuit. If the impedance is less than 100 ohms, the circuit is “closed,” otherwise, the circuit is “open.”

- Tap **Reset** to return to the original state.

NOTE

1. AC/DC current is measured with clamps, while AC/DC voltage, diode and connectivity are measured with probes.
2. When selecting the **Resistance** measurement type, the self-calibration mark  will display beside **Resistance**, indicating the multimeter will return to zero in order to improve accuracy.
3. When measuring AC/DC current, different measuring ranges require different operations of the clamp. Tap **no more** to hide diagram.

9 Settings

Access the Settings menu to adjust default settings and view information about the MaxiSys system. The following options are available for the MaxiSys system settings:

- Unit
- Language
- Printing Settings
- Notification Center
- Auto Update
- ADAS Settings
- Vehicle List
- Battery Test
- Country/Region Code
- System Settings
- About

This section describes the operation procedures for the settings.

9.1 Unit

This option allows you to change the measurement unit for the diagnostics system.

➤ To change the unit setting

1. Tap the **Settings** application on the MaxiSys Job Menu.
2. Tap the **Unit** option on the left column.
3. Select the appropriate measurement unit. A check mark displays to the right of the selected unit.
4. Tap the **Home** button on the top left corner to return to the MaxiSys Job Menu, or select another setting option for the system setup.

9.2 Language

This option allows you to change the display language for the MaxiSys system.

➤ To adjust the language setting

1. Tap the **Settings** application on the MaxiSys Job Menu.
2. Tap the **Language** option on the left column.

3. Select the appropriate language. A check mark displays to the right of the selected language.
4. Tap the **Home** button on the top left corner to return to the MaxiSys Job Menu, or select another setting option for the system setup.

9.3 Printing Settings

Printing Settings

This option allows you to print from the tablet to a network printer via a computer.

➤ **To set up the printer connection**

1. Tap **Settings** on the MaxiSys Job Menu.
2. Tap **Printing Settings** on the left column.
3. Tap **Print via Network** to activate the printing function, which enables the device to send files to the printer through the PC via Wi-Fi or Ethernet connection.
4. Tap **Home** on the top-left corner to return to the MaxiSys Job Menu, or select another setting option for the system setup.

Printing Operations

➤ **To install the MaxiSys Printer driver program**

1. Download **Maxi PC Suite** from www.autel.com > *Support* > *Downloads* > *Autel Update Tools*, and install to your Windows-based PC.
2. Double-click on **Setup.exe**.
3. Select an installation language and the wizard will load.
4. Follow the instructions on the screen and click **Next** to continue.
5. Click **Install** and the printer driver program will be installed to the computer.
6. Click **Finish** to complete the installation.

🔗 **NOTE**

The MaxiSys printer runs automatically after the installation.

This section describes how to receive files from the MaxiSys tablet and perform printing through the computer:

➤ **To print from a computer**

1. Make sure the tablet is connected to the computer network, via Wi-Fi or LAN, before printing.
2. Run the **MaxiSys Printer** program on the computer.
3. Click **Test Print** to check whether the printer works properly.
4. Tap the **Print** button on the toolbar of the tablet. A test document will be sent to the computer.

- If the **Auto Print** option in the MaxiSys Printer is selected, the MaxiSys printer will automatically print the received document.
- If the **Auto Print** option in the MaxiSys Printer is not selected, click the **Open PDF File** button to view files. Select the file(s) to be printed and click **Print**.

 **NOTE**

Make sure the computer installed with the Printing Services program is connected to a printer.

9.4 Notification Center

This option allows you to turn the Notification Center function on or off. The Notification Center function configures the MaxiSys tablet to receive regular online messages from the server for system update notifications or other service information via the Internet. It is highly recommended that the Notification setting be on at all times so as not to miss news of updates or important service messages. Internet access is required for receiving online messages.

➤ **To enable the Notification Center function**

1. Tap **Settings** on the MaxiSys Job Menu.
2. Tap **Notification Center** on the left column.
3. Tap **ON/OFF** to enable or disable the Notifications function. If the function is enabled, the button displays blue, or if disabled, the button displays gray.
4. Tap **Home** on the top-left corner to return to the MaxiSys Job Menu, or select another setting option for the system setup.

When the Notification Center function is turned on and new messages are received by the MaxiSys device, a notification message displays on the MaxiSys Job Menu. Press on the message bar and drag it down to display a list of received messages. Slide the list up or down to view additional messages if present.

Tap a specific message to launch the corresponding application. For example, if you tap on an Update notification message, the Update application will be launched.

9.5 Auto Update

This option allows you to preset a time to update the software. There are three update options: OS Update, MaxiSys Update, and Vehicle Update.

Tap **ON/OFF** to enable or disable the Auto Update. The button displays blue if Auto Update is enabled and displays grey if the Auto Update is disabled. Set the time of the day for updating. If a specific time is set, the selected software will be automatically updated at this specific time.

9.6 ADAS Settings

Advanced Driver Assistance Systems (ADAS) is an array of vehicle systems that aid the driver either through passive alerts or by active control of the vehicle to drive safer and with greater awareness and precision.

MaxiSys MS909CV is bound to the main frame when it leaves the factory, and you can configure related settings through the following steps:

➤ To adjust the ADAS setting

1. Tap the **Settings** application on the MaxiSys Job Menu.
2. Select **ADAS settings** on the left column.
3. Follow the on-screen instructions to complete the settings.

9.7 Vehicle List

This option allows you to sort the vehicles either by alphabetic order or by frequency of use.

➤ To adjust the vehicle list setting

1. Tap the **Settings** application on the MaxiSys Job Menu.
2. Select **Vehicle list** on the left column.
3. Select the required sort type. A check mark will display to the right of the selected language.
4. Tap the **Home** button on the top-left corner to return to the MaxiSys Job Menu, or select another setting option for system setup.

9.8 Battery Test

➤ To adjust the battery test setting

1. Tap the **Settings** application on the MaxiSys Job Menu.
2. Select **Battery test** on the left column.
3. Switch on **Current clamp** and then you can measure the current when doing the battery test; switch on **Visual inspection** to access the visual inspection when doing the battery test.
4. Tap the **Home** button in the top left corner to return to the MaxiSys Job Menu. Or select another setting option for system setup.

9.9 Country/Region Code

This function provides Wi-Fi channel options for different country regions to ensure reliable and stable Wi-Fi communication. Please connect the tablet with VCI device before making adjustment.

➤ To adjust the country code setting

1. Tap the **Settings** application on the MaxiSys Job Menu.
2. Tap the **Country/Region Code** option on the left column.
3. Select your country/Region region. A message displays to confirm your selection.
4. Tap the **Home** button on the top left corner to return to the MaxiSys Job Menu, or select another setting option for the system setup.

🔗NOTE

If the tablet can NOT find the VCI device via Wi-Fi connection after setting the country code, please use the USB or Bluetooth connection to retry.

9.10 System Settings

This function provides you with direct access to the Android system settings interface, where you can adjust various system settings for the Android system platform, regarding wireless and networks settings, various device settings such as sound and display, as well as system security settings, and check related information about the Android system. Refer to Android documentation for additional information.

9.11 About

The About function provides information of the MaxiSys diagnostics device, including the product name, version, hardware, and serial number.

➤ To check the MaxiSys product information in About

1. Tap the **Settings** application on the MaxiSys Job Menu.
2. Select the **About** option on the left column. The product information screen displays on the right.
3. Tap the **Home** button on the top-left corner to return to the MaxiSys Job Menu, or select another setting option for the system setup after viewing.

10 Data Manager

The Data Manager application allows you to store, print, and review the saved files, manage the workshop information, customer information records and keep test vehicle records.

Selecting the Data Manager application opens the file system menu. There are eight main functions available.

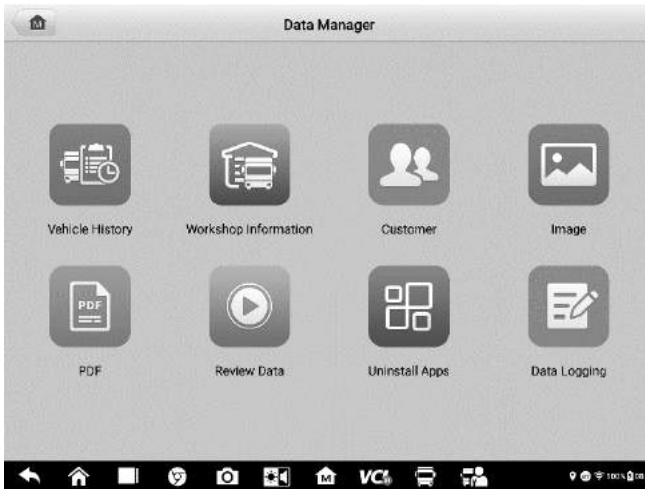









Figure 10-1 Sample Data Manager Main Screen

The table below describes each of the function buttons in the Data Manager application.

Table 10-1 Buttons in Data Manager

Name	Button	Description
Vehicle History		Tap to view the diagnostic records.
Workshop Information		Tap to view or edit the workshop information.
Customer		Tap to create a new customer account file.
Image		Tap to view the screenshots.
PDF		Tap to view the diagnostic reports.

Name	Button	Description
Review Data		Tap to view the recorded data.
Uninstall Apps		Tap to uninstall applications.
Data Logging		Tap to view communications with Autel support service and ECU information of the test vehicle. The saved data can be reported and sent to the technical center via the Internet.

10.1 Vehicle History

This function stores records of test vehicle history, including vehicle information and the retrieved DTCs from previous diagnostic sessions. Test information is summarized and displayed in an easy-to-read table listing. The Vehicle History also provides direct access to the previously tested vehicle and allows you to directly restart a diagnostic session without needing to perform auto or manual vehicle selection.



Figure 10-2 Sample Vehicle History Screen

1. Top Toolbar Buttons — navigation and application controls.
 2. Main section — displays all the vehicle records.
- **To activate a test session for the recorded vehicle**
1. Tap **Data Manager** on the MaxiSys Job Menu.

2. Select **Vehicle History** to open the screen. Tap **Diagnostics** or **Service** to select diagnostic test records or service test records.
3. Tap **Diagnostics** icon at the bottom of the thumbnail of a vehicle record item.
4. The Diagnostics screen of the vehicle displays and a new diagnostics session is activated. See [Diagnostics](#) for detailed instructions on vehicle diagnostics operations. Or select a vehicle thumbnail to select a record. A Test Records window appears. Review the recorded information of the test vehicle, and tap the **Diagnostics** button on the upper-right corner to continue diagnostics.

10.1.1 Test Records

A Test Record is a detailed data form of the tested vehicle, which includes general vehicle information, service record, customer information, and the diagnostic trouble codes retrieved from previous test sessions. Technician Notes will also display if present.

NOTE

The MaxiSys tablet must establish a connection to the VCI to restart test sessions on a previously tested vehicles.



Historical test

Title: (J)2018 ISUZU N series

Diagnostics

Vehicle information

Year	(J)2018	License plate	
Make	ISUZU	VIN	
Model	N series	Odometer	
Sub model		Color	
Engine	4HK1	Status	Not started

Service record

Technician

Technician Notes

Customer information

Figure 10-3 Sample Test Records Sheet

➤ To edit the Test Records

1. Tap **Data Manager** on the MaxiSys main screen.
2. Select **Vehicle History**.
3. Select a specific vehicle history record thumbnail from the main section. The test record will display.
4. Tap the **Edit** button (the pen icon) to start editing.
5. Tap each item to enter information or attach files or images.

6. Tap **Add a Customer** to associate the test record sheet to an existing customer account, or add a new account to be associated with the test vehicle record. See [Customer](#) for more information.
7. Tap **Done** to save the updated record, or tap **Cancel** to exit without saving.

NOTE

The vehicle VIN, license number and customer account are associated by default. Vehicle records will automatically be associated using this vehicle and customer identification.

10.2 Workshop Information

Workshop Information allows you to enter, edit, and save detailed workshop information, such as shop name, address, phone number and other remarks, which, when printing vehicle diagnostics reports and other associated test files, will appear as the header of your printed documents.

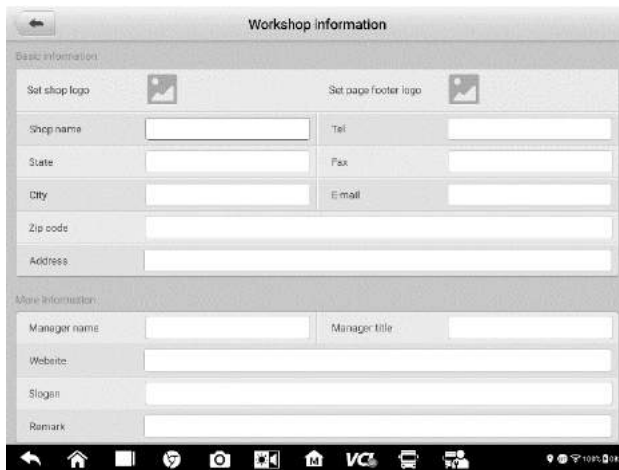

Figure 10-4 Sample Workshop Information Sheet

➤ **To edit the Workshop information sheet**

1. Tap **Data Manager** on the MaxiSys Main Screen.
2. Select **Workshop Information**.
3. Tap on each field to enter the corresponding information.
4. Tap **Done** to save the updated workshop information, or tap **Cancel** to exit without saving.

10.3 Customer

The Customer function allows you to create and edit customer accounts. It helps you to save and organize all customer accounts associated with the test vehicle records.

➤ **To create a customer account**

1. Tap the **Data Manager** application on the MaxiSys main screen.
2. Select **Customer**.
3. Tap the **Add a customer** button. A blank information form appears. Tap each field to enter the appropriate information.

🕒 **NOTE**

Required fields are denoted by an asterisk.

4. For customers with more than one vehicle for service, tap **Add New Vehicle Information**. To delete the added vehicle information, tap the **✕** button.
5. Tap **OK** on the upper-right corner of the screen to save the customer information, or tap **Cancel** to exit without saving.

➤ **To edit a customer account**

1. Tap **Data Manager** on the MaxiSys Job Menu.
2. Select **Customer**.
3. Select a customer account by tapping the corresponding name card. A Customer Information record displays.
4. Tap **Edit** on the top toolbar to start editing.
5. Tap on the input field to edit the information.
6. Tap **Complete** to save the updated information, or tap **Cancel** to exit without saving.

➤ **To delete a customer account**

1. Tap **Data Manager** on the MaxiSys Job Menu.
2. Select **Customer**.
3. Select a customer account by tapping the corresponding name card. A Customer Information record appears.
4. Tap **Edit** on the top toolbar to start editing.
5. Tap **Delete** on the top of the screen. A reminder message appears.
6. Tap **OK** to confirm the command, and delete the account. Tap **Cancel** to cancel the request.

10.4 Image

The Image section is a database containing all captured screenshots.

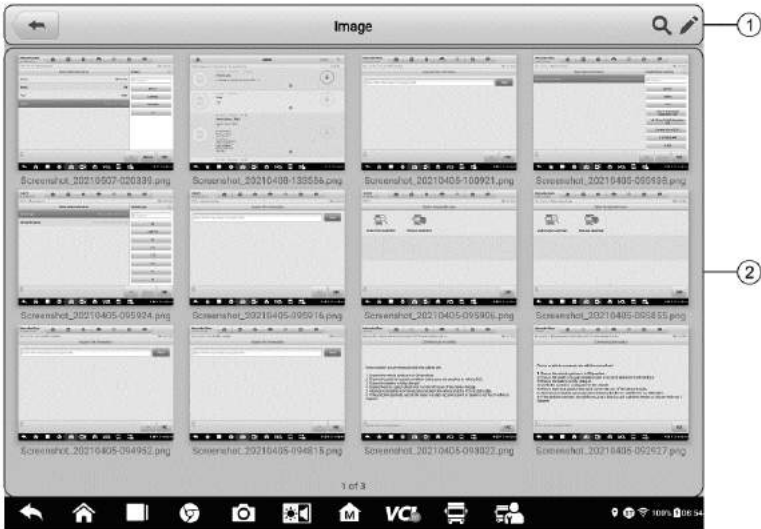



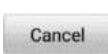





Figure 10-5 Sample Image Database Screen

1. **Toolbar Buttons** — used to edit, print or delete the image files. See [Table 10-2 Toolbar Buttons Description](#) below for detailed information.
2. **Main Section** — displays the stored images.

Table 10-2 Toolbar Buttons Description

Name	Button	Description
Back		Return to the previous screen.
Search		Tap to enter the search page.
Edit		Tap to display the editing toolbar to print, delete or view image.
Cancel		Tap to close the editing toolbar or cancel file search.
Search		Quickly searches the image by entering the time of the screenshot.
Print		Tap to print the selected image.
Delete		Tap to delete the selected image.
Email		Tap to attach the selected image to an email.

➤ **To edit/delete image(s)**

1. Select **Data Manager** from the MaxiSys Job Menu.

2. Select **Image** to access the image database.
3. Tap **Edit** on the top-right corner of the window. The editing screen appears.
4. Select the image(s) you want to edit by tapping the check box at the bottom-right corner of the image.
5. Tap **Delete** to delete the selected images or delete all images. Tap **Print** icon to print the selected image(s). Tap **Email** to attach the selected image(s) to an email.

10.5 PDF Files

The PDF section stores and displays all PDF files of saved data. After entering the PDF database, select a PDF file to view the stored information.

This section uses the standard Adobe Acrobat Reader application for file viewing and editing. Please refer to the associated Adobe Acrobat Reader manual for more detailed instructions.

10.6 Review Data

The Review Data function allows you to playback the recorded data frames from live data streams.

On the Review Data main screen, select a record to play back.



Figure 10-6 Sample Data Playback Screen

1. Main Section — displays the recorded data frames.
2. Navigation Toolbar — allows you to manipulate data playback.

Use the Navigation Toolbar buttons to play back the record data from frame to frame.

Tap **Back** to exit data playback.

10.7 Uninstall Apps

This section allows you to manage the firmware application installed on the MaxiSys Diagnostics System. Selecting this section opens a management screen, on which you can check all the available vehicle diagnostics applications.

Select the vehicle firmware you want to delete by tapping on the car brand icon. The selected item will display a blue check mark on the upper-right corner. Tap the **Delete** button on the top bar to delete the firmware from the system database.

10.8 Data Logging

The Data Logging section allows you to launch the Support platform to view all records with or without feedback (saved) data logs on the diagnostics system. For more information, please refer to [Data Logging](#).

11 VCI Manager

VCI Manager is for connecting the MaxiSys MS909CV tablet with a VCI device through Wi-Fi or Bluetooth. This application allows you to pair the tablet with the VCI device and to check its communication status. You can either establish the connection via Bluetooth or Wi-Fi, of which the latter is more stable and faster for module operation.

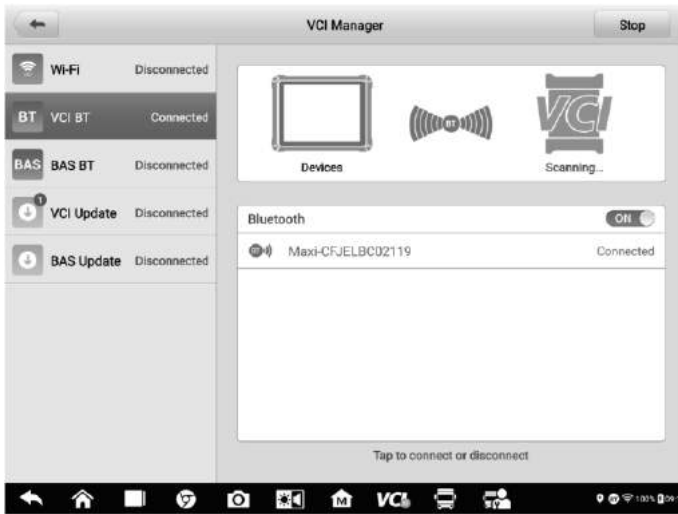

Figure 11-1 Sample VCI Manager Screen

11.1 VCI Connection via Wi-Fi

Wi-Fi Connection is an advanced function for quick link with a VCI. Since Wi-Fi connection supports 5G, the MaxiSys MS909CV tablet and VCI share a faster and more stable connection when using this communication method. The tablet can be operated up to 50 meters away from the VCI device when connected to the vehicle via Wi-Fi.



Figure 11-2 Sample Wi-Fi Connection Screen

➤ **To connect the VCI device with the tablet via Wi-Fi**

1. Power on the tablet.
2. Connect the 26-pin end of the data cable to the VCI's vehicle data connector.
3. Connect the 16-pin end of the data cable to the vehicle data link connector (DLC).
4. Tap **VCI Manager** on the MaxiSys Job Menu of the tablet.
5. Select **Wi-Fi** from the connection mode list.
6. Tap the Wi-Fi Toggle to turn it **ON**. Tap **Refresh** at the top-right corner. The device will start to search for available units.
7. Depending on the VCI type you use, the device name may appear as Maxi suffixed with a serial number. Select the appropriate device for connection.
8. When connection is established, the connection status reads "Connected".
9. The VCI button on the system Navigation Bar at the bottom of the screen displays a green Wi-Fi icon, indicating the tablet is connected to the VCI device.
10. To disconnect the device, tap the connected device again.
11. Tap **Back** on the top-left to return to the MaxiSys Job Menu.

NOTE

To ensure a fast connection, perform this operation in a steady network environment.

11.2 VCI Connection via Bluetooth

Bluetooth Pairing provides a simple wireless connection. The VCI device needs to be either connected to a vehicle or to an available power source, so that it is powered up during the synchronization procedure. Make sure the tablet has a fully charged battery or is connected to an external power supply.



Figure 11-3 Sample VCI Bluetooth Pairing Screen

➤ To pair the VCI device with the tablet via Bluetooth

1. Power on the tablet.
2. Connect the 26-pin end of the data cable to the VCI's vehicle data connector.
3. Connect the 16-pin end of the data cable to the vehicle data link connector (DLC).
4. Tap **VCI Manager** on the MaxiSys Job Menu of the tablet.
5. Select **VCI BT**, short for VCI Bluetooth, from the connection mode list.
6. Toggle Bluetooth **ON**. Tap **Scan** at the top-right corner. The device will start searching for available units for pairing.
7. Depending on the VCI you use, the device name may appear as "Maxi" suffixed with the VCI's serial number. Select the appropriate device for pairing.
8. When paired successfully, the connection status reads "Connected".
9. After a few seconds, the VCI button on the system Navigation Bar at the bottom of the screen will display a green check mark, indicating the tablet is connected to the VCI device.
10. To disconnect the device, tap the connected device again.

11. Tap **Back** on the top-left to return to the MaxiSys Job Menu.

NOTE

A VCI device can be paired with only one tablet at a time, and once it's been paired, the device will not be discoverable by any other unit.

11.3 BAS Connection via Bluetooth

The MaxiBAS B200 device needs to be either connected to a vehicle or to an available power source, so that it is powered up during the synchronization procedure. Make sure the tablet is fully charged or is connected to an external power supply.

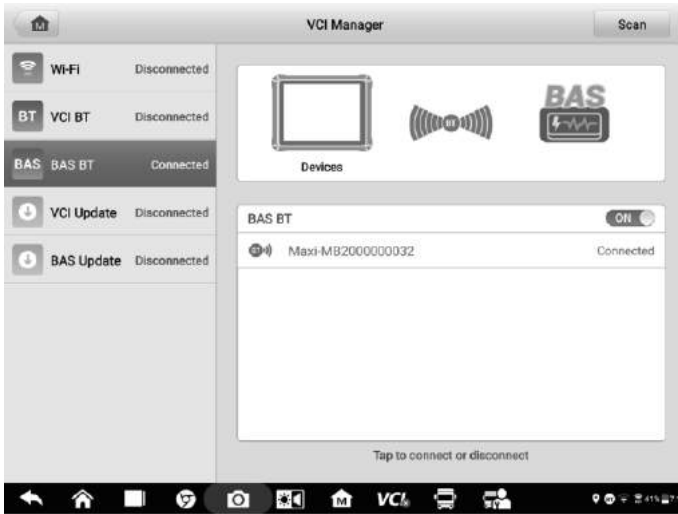

Figure 11-4 Sample BAS Bluetooth Pairing Screen

➤ **To pair the B200 series tester with the tablet**

1. Press and hold the **Power** Button to turn on the MaxiSys MS909CV. Ensure that the unit is sufficiently charged before using.
2. Power on the MaxiBAS B200. Connect the red clamp to the positive (+) terminal and the black clamp to the negative (-) terminal of the battery.
3. Enable **Bluetooth** on the MS909CV by tapping **VCI Manager > BAS BT**, and the tablet automatically scans for an available tester for Bluetooth pairing. The device name will appear as “Maxi” suffixed with a serial number.
4. Check the serial number of your B200 series tester and select the desired device on the tablet for pairing.
5. When paired successfully, the connection status will read as “Connected” and

the status LED will light solid blue.

6. To disconnect the device, tap the connected device again.
7. Tap **Back** on the top-left to return to the MaxiSys Job Menu.

NOTE

A VCI device can be paired to only one tablet at a time, and once it's been paired, the device will not be discoverable by any other unit.

11.4 VCI Update

The VCI Update provides the latest update for the MaxiFlash VCI. Before updating the VCI firmware, please make sure the tablet network is stable.

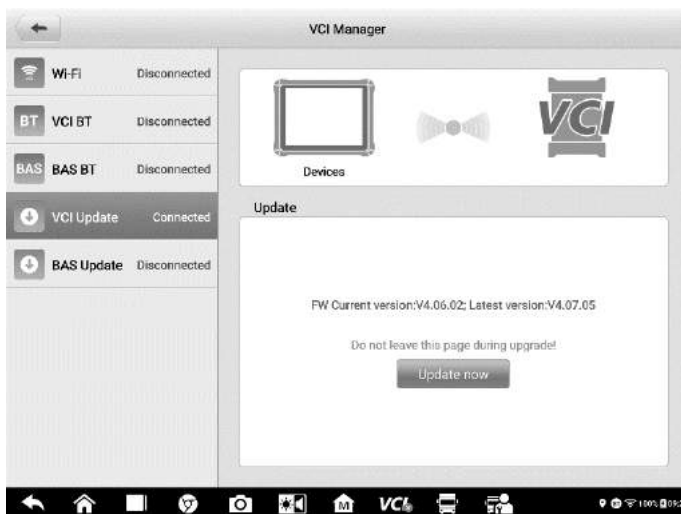

Figure 11-5 Sample VCI Update Screen

➤ To update the VCI firmware

1. Power on the tablet.
2. Connect the 26-pin end of the data cable to the VCI's vehicle data connector.
3. Connect the 16-pin end of the data cable to the vehicle data link connector (DLC).
4. Connect the VCI device to the tablet via Wi-Fi or USB.
5. Tap **VCI Manager** on the MaxiSys Job Menu of the tablet.
6. Select **VCI Update** from the connection mode list.
7. The current version and the latest version of the VCI firmware will appear. Tap **Update Now** to update the VCI firmware.

11.5 BAS Update

The BAS Update provides the latest update for the MaxiBAS B200. Before updating the BAS firmware, please make sure the tablet network is stable.

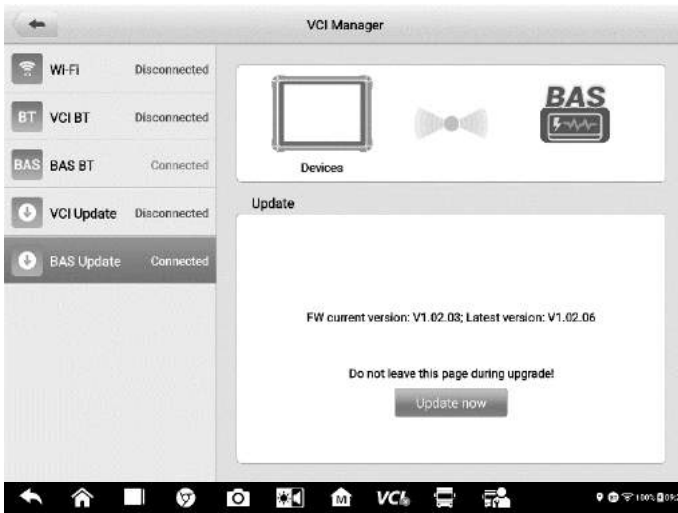

Figure 11-6 *Sample VCI Update Screen*

➤ **To update the MaxiBAS B200 firmware**

1. Power on the tablet and the MaxiBAS B200.
2. Connect the MaxiBAS B200 device to the tablet via Bluetooth or USB.
3. Tap **VCI Manager** on the MaxiSys Job Menu of the tablet.
4. Select **BAS Update** from the connection mode list.
5. The current version and the latest version of the MaxiBAS B200 firmware will appear. Tap **Update Now** to update the MaxiBAS B200 firmware.

12 Update

The internal programming of the MaxiSys Diagnostics System, known as the firmware, can be updated using the Update application. Firmware updates increase the MaxiSys applications' capabilities, typically by adding new tests, new models, or enhanced applications to the database.

The display device automatically searches for available updates for all of the MaxiSys components when it is connected to the Internet. Any updates that are found can be downloaded and installed on the device. This section describes installing an update to the MaxiSys Diagnostics System firmware. A notification message displays if an update is available when the Notifications function is enabled in the **Settings** application (See [Notification Center](#)).

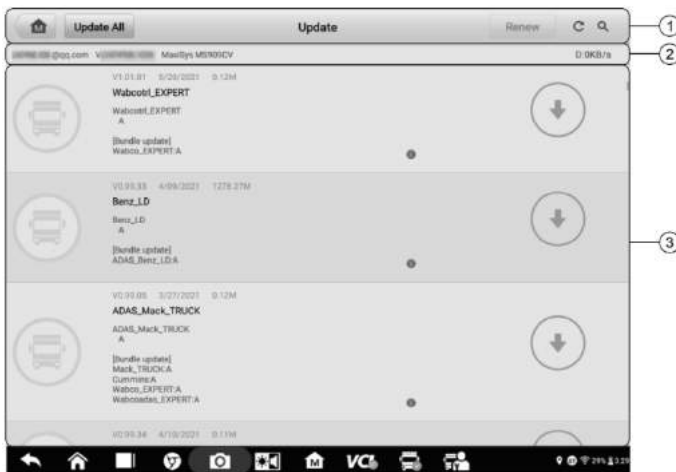

Figure 12-1 Sample Update Screen

1. Navigation and Controls
 - Home Button — return to the MaxiSys Job Menu.
 - Update All — available updates for all tablet systems.
 - Search Bar — searches specific update item by inputting the file name, for example, a specific vehicle manufacturer.
2. Status Bar
 - Left Side — displays the MaxiSys device model information and serial number.
 - Right Side — displays an update progress bar indicating the completion status.
3. Main Section
 - Left Column — displays vehicle logos and update firmware version information.

- Middle Column — displays a brief introduction about the new changes to the firmware operation or capabilities. Tap ⓘ button to display an information screen to view more details, and tap the dim area around to close the window.
- Right Column — according to the operation status of each firmware item, the button appears differently.
 - a) Tap **Update** to update the selected item.
 - b) Tap **Pause** to suspend the updating procedure.
 - c) Tap **Continue** to go on updating the suspended update.

➤ **To update the firmware**

1. Power up the tablet, and ensure that it is connected to a power source and has a steady Internet connection.
2. Tap the **Update** application button from the MaxiSys Job Menu, or tap the update notification message when received. The Update application screen appears.
3. Check all available updates:
 - To update all the items, tap the **Update All** button.
 - To update some individual items, tap the **Update** button on the right column of the specific item. This option is highly recommended to ensure updates are performed correctly, especially when you are unsure of the speed and stability of your Internet connection.
4. Tap the **Pause** button to suspend the updating process. Tap **Continue** to resume the update and the process will continue from the pause point.
5. When the updating process is completed, the firmware will be installed automatically. The new version will replace the older version.

13 Support

This application launches the Support platform which synchronizes Autel's online service base station with the MaxiSys tablet. In order to synchronize the device to your online account, you need to register the product through the Internet when you use it for the first time. The Support application is connected to Autel's service channel and online communities that provides the quickest way for problem solutions, send help requests to obtain direct service and support.

13.1 Product Registration

In order to get access to the Support platform and obtain update and other services from Autel, you are required to register the MaxiSys Diagnostics Device the first time you use it.

➤ To register the diagnostics device

1. Visit the website: <http://pro.autel.com>.
2. If you have an Autel account, sign in with your account ID and password.
3. If you are a new member to Autel, click on the **Create Autel ID** button on the left side to create an ID.
4. Enter the required information in the input fields, and click **Get Verification Code** button to get the verification code for email validation.
5. The online system will automatically send a verification code to the registered email address. Input the code in the Verification Code field and fill in other input fields, read through Autel's Terms and Conditions and click on **Agree**, and then click **Create Autel ID** at the bottom. A product registration screen will display.
6. The device's serial number and password is located in the [About](#) section of the Settings application on the tablet.
7. Select your product model, enter the product serial number and password on the Product Registration screen, and tap **Submit** to complete the registration procedure.

13.2 Support Screen Layout

The Support application interface is navigated by the **Home** button on the top navigation bar.

- **Home** button — returns to the MaxiSys Job Menu.



Figure 13-1 Sample Support Application Screen

The main section of the Support screen is divided into two sections. The narrow column on the left is the main menu: select one subject from the main menu displays the corresponding function interface on the right.

13.3 My Account

The My Account screen displays the comprehensive information of the user and the product, which is synchronized with the online registered account, including User Info, Device Info, Update Info, and Service Info.

13.3.1 Personal Info

The User Info and Device Info are both included under the Personal Info section.

- User Info — displays detailed information of your registered online Autel account, such as your Autel ID, Name, Address and other contact information.
- Device Info — displays the registered product information, including the Serial Number, Registration Date, Expire Date, and Warranty Period.

13.3.2 Update Info

The Update Info section displays a detailed list of the product's software update history, including the product serial number, software version or name, and the update time.

13.3.3 Service Info

The Service Info section displays a detailed record list of the device's service history information. Each time the device is sent back to Autel for repair, the device's serial number and the detailed repair information, such as the fault type, changed components, or system reinstallation, will be recorded and updated to the associated online product account that will be synchronized to the Service Info section.

13.4 Training

The Training section provides quick links to Autel's online video accounts. Select a video channel by language to see all available Autel online tutorial videos on such topics as product usage techniques and vehicle diagnostics practices.

13.5 Data Logging

The Data Logging section keeps records of all **Feedback** (submitted), **Not Feedback** (but saved) or **History** (up to the latest 20 test records) data loggings on the diagnostics system. The support personnel will receive and process the submitted reports through the Support platform. The solution will be sent back within 48 hours. You may continue to correspond with Support until the issue is resolved.

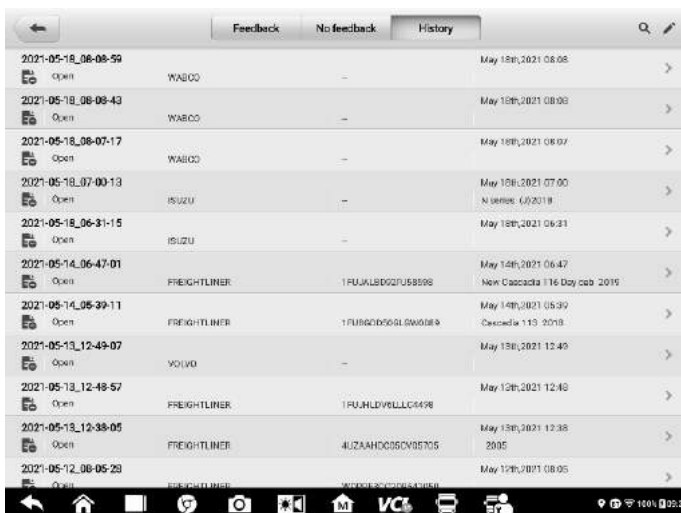

Figure 13-2 Sample Data Logging Screen

- **To make a reply in a Data Logging session**
 1. Tap the **Feedback** tab to view the submitted data loggings.
 2. Select the latest message from Autel support service.

3. Tap the input field at the bottom of the screen and enter your reply, or tap the **Audio** button to record a voice message, or tap the **Camera** button to take a screenshot.
4. Tap **Send** to send your reply to Support.

13.6 FAQ Database

The FAQ section provides comprehensive references for all questions frequently asked and answered about the use of Autel's online member account, shopping, and payment procedures.

- Account — displays questions and answers about the use of Autel's online user account.
- Shopping & Payment — displays questions and answers about online product purchase and payment methods or procedures.

14 MaxiViewer

MaxiViewer allows you to search the functions supported by our tools and the version information. There are two ways of searching, either by searching the tool and the vehicle or searching the functions.

➤ To search by vehicle

1. Tap the **MaxiViewer** application on the MaxiSys Job Menu. The **MaxiViewer** application screen displays.
2. Tap the tool name on the top-left to drop down the tool list, and tap the one you want to search.
3. Tap the vehicle brand, model, and year you want to search.



Figure 14-1 Sample MaxiViewer Screen 1

4. All the functions supported by the selected tool for the selected vehicle are displayed within three columns: function, sub function, and version.

The screenshot shows the MaxiViewer application interface. At the top, there are dropdown menus for 'MaxiSys MS909CV', 'GMC Truck/C - T Ser. / (4) 2004', and 'System'. A search icon and a list icon are in the top right. Below these is a table with the following columns: System, Type, Function, Sub-function, and Version. The table contains six rows of data. At the bottom, there is an Android-style navigation bar with icons for back, home, recent apps, camera, gallery, home, VCI, and a user profile icon. The status bar at the very bottom shows signal strength, Wi-Fi, and 100% battery.

System	Type	Function	Sub-function	Version
Serial data gateway (if equipped)	Medium duty truck	ECU information	/	Above CVTGMC_V1.00
Serial data gateway (if equipped)	Medium duty truck	Trouble codes	/	Above CVTGMC_V1.00
Hydraulic 4WAL 4 sensor	Medium duty truck	Special function	New tire/wheel base/booster information	Above CVTGMC_V1.00
Hydraulic 4WAL 4 sensor	Medium duty truck	ECU information	/	Above CVTGMC_V1.00
Hydraulic 4WAL 4 sensor	Medium duty truck	Active test	/	Above CVTGMC_V1.00
Hydraulic 4WAL 4 sensor	Medium duty truck	Trouble codes	/	Above CVTGMC_V1.00

Figure 14-2 Sample MaxiViewer Screen 2

➤ **To search by the functions**

1. Tap the MaxiViewer application on the MaxiSys Job Menu. The MaxiViewer application screen displays.
2. Tap the tool name on the top-left to drop down the tool list, and tap the one you want to search.
3. Enter the function you want to search in the top-right search box. The screen will display all vehicles that support this function, along with information such as the vehicles' year, system, capacity, type, function, sub-function, and version.

NOTE

Fuzzy search is supported. Type in some part of the function-related keywords to find all available information.

15 MaxiVideo

The MaxiVideo application configures the MaxiSys Diagnostics Device to operate as a digital video scope by simply connecting the tablet to a MaxiVideo Camera. This function allows you to examine difficult-to-reach areas normally hidden from sight, with the ability to record digital still images and videos, which offers you an economical solution to inspect machinery, facilities, and infrastructure in a safe and quick way.

WARNING & IMPORTANT:

Follow these instructions to reduce the risk of injury from electric shock, entanglement and other causes and prevent tool damage.

- Do not place the imager head into anything or anywhere that may contain a live electric charge or moving parts, which increases the risk of electric shock or entanglement injuries.
- Do not use the imager head cable to modify surroundings, clear pathways or clogged areas.
- When inspection is completed, carefully withdraw the imager head from the inspected area.
- The imager head cable is waterproof to a depth of 3m (10'). Greater depths may cause leakage into the imager head cable, electric shock or tool damage.
- The working temperature of the imager head is between 32 °F (0 °C) and 113 °F (45 °C).

Check-Ups:

- ✓ **FOR AUTOMOBILES:** Ensure the automobile is not running during inspection to avoid damage from hot metal and liquid under the hood. Do not get oil or gasoline on the imager head.
- ✓ **FOR PIPES:** If you suspect that a metal pipe may carry electric charge, have a qualified electrician to check the pipe before inspecting it.
- ✓ **FOR WALLS:** Before you inspect the inside of a wall with the imager head, turn off the circuit breaker to the house.
- ✓ **WORK AREA:** Ensure the work area has sufficient light.

15.1 Additional Accessories

The MaxiVideo Camera and its fittings are the additional accessories. Both sizes (8.5 mm and 5.5 mm) of the imager head are optional and available for purchase along with the standard MaxiSys tool kit.

15.1.1 MaxiVideo Camera

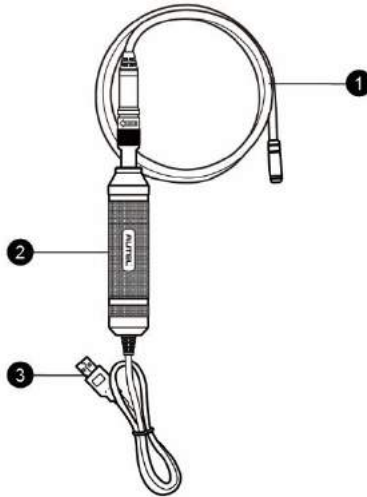

Figure 15-1 *MaxiVideo Camera*

1. Removable Imager Head Cable — connects to the tool when performing MaxiVideos for image and video viewing.
2. Handgrip — ergonomically designed handle for comfortable grips and agile operation.
3. USB Cable — connects the MaxiVideo Camera to the MaxiSys tablet.

15.1.2 Imager Head Accessories

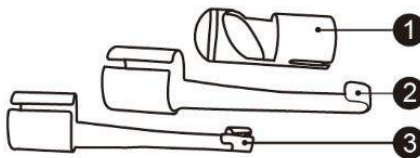

Figure 15-2 *8.5mm Imager Head Accessories*

1. Magnet — picks up small metal objects such as dropped rings or screws.
2. Hook — unclogs obstacles and picks up wires in the pipes or confined areas.
3. Mirror — helps to look around corners and see the unreachable areas.

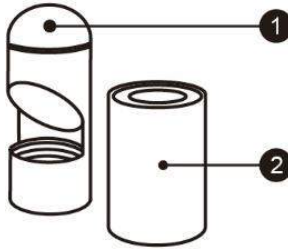

Figure 15-3 5.5mm Imager Head Accessories

1. Mirror — helps to look around corners and see the unreachable areas.
2. Magnet — picks up small metal objects, such as dropped rings or screws.

15.1.3 Accessory Assembly

15.1.3.1 For 8.5mm Imager Head

The three accessories, including the Magnet, Hook, and Mirror, can be attached to the Imager Head in the same manner described below:

1. Hold the accessory and the imager head.

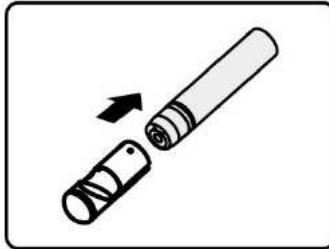

2. Slip the end of the accessory over the imager head and then fix the accessory.

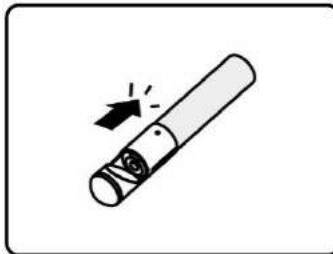

15.1.3.2 For 5.5mm Imager Head

The two accessories, the Magnet and Mirror, can be attached to the Imager Head in the same manner described below:

1. Hold the accessory and the imager head.

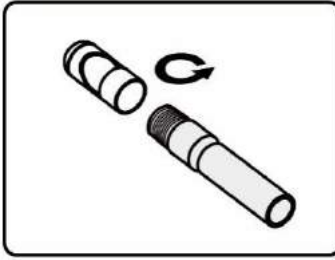

2. Screw the thread part of the accessory over the imager head to fix the accessory.

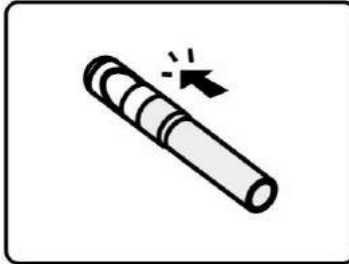

15.1.4 Technical Specifications

Table 15-1 Specifications

Item	Description
Optimal Viewing Distance	1" to 14" (2.54cm to 35.56cm) with 8.5mm-diameter imager head 3/8" to 12" (0.95cm to 30cm) with 5.5mm-diameter imager head
Resolution	JPG images (640x480) AVI videos (320 x 240)
Operating Temperature	Main Unit: 0°C to 55°C (ambient) Cable: -10°C to 70°C
Storage Temperature	-20°C to 75°C (ambient)
Waterproof	Imager head and cable to 1m
Weight	0.3 kg for 8.5 mm diameter imager head 0.2 kg for 5.5 mm diameter imager head

15.2 Operations

Before opening the MaxiVideo application, the imager head cable must be connected to the tablet through the USB port. Install the correct imager head accessories according to the specific needs.

NOTE

When in operation, the imager head cable can be manipulated so as to better access confined or awkward spaces.

➤ **To take images using the MaxiVideo application**

1. Connect the imager head cable to the USB port on the top of the tablet.
2. If not already done, power up the tablet.
3. Tap the **MaxiVideo** application on the MaxiSys Job Menu. The MaxiVideo interface displays, showing a camera operating screen. The imager head camera is used by default.
4. Select the **Camera** icon at the lower-right corner to take images.
5. Focus the image to be captured in the view finder by adjusting and properly locating the imager head cable.
6. Tap the blue ring on the screen. The view finder now displays the captured picture and auto-saves the taken photo.
7. Tap the thumbnail image on the top-right corner of the screen to view the stored image. Slide the screen left and right to view the images.
8. Tap on the selected image and the edit toolbar instantly displays.
9. Tap the corresponding button to **share** or **delete** an image.
10. Tap the **Back** or **Home** button on the Navigation Bar at the bottom of the screen to exit the MaxiVideo application.

➤ **To record a video using the MaxiVideo application**

1. Connect the imager head cable to the USB port on the top side of the tablet.
2. If not already done, power up the tablet.
3. Tap the **MaxiVideo** application on the MaxiSys Job Menu. The MaxiVideo interface displays, showing a camera operating screen. The Imager head camera is used by default.
4. Select the **Video** icon at the lower-right corner to record a video.
5. Properly locate the imager head cable to focus the inspection scene for recording.
6. Tap the red ring on the operating screen to start recording.
7. Tap the red circle again to stop recording. The recorded video is automatically saved.
8. Tap the gallery icon at the bottom-right corner to review all recorded videos.

9. Select the corresponding button on the upper-right corner to search or delete a video.

16 Quick Link

The Quick Link application provides you with convenient access to Autel's official website and many other well-known sites in automotive service, which offers you abundant information and resources, such as technical help, knowledge bases, forums, training and expert consultations.

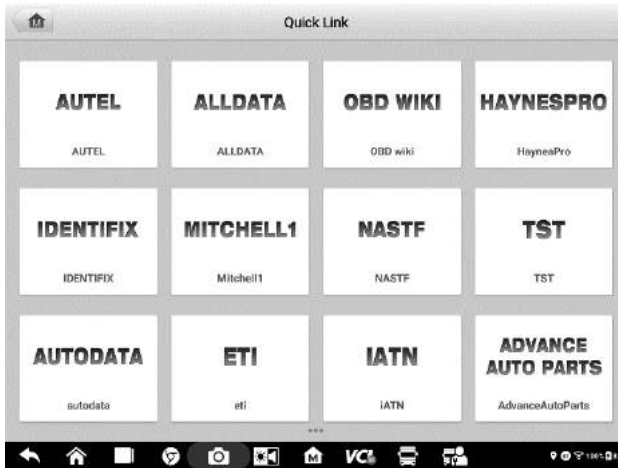

Figure 16-1 Sample Quick Link Screen

➤ **To open a quick link**

1. Tap **Quick Link** on the MaxiSys Job Menu. The Quick Link application screen displays.
2. Select a website thumbnail from the main section. The Chrome browser is launched and the selected website is opened.
3. Now you can start exploring the website.

17 Remote Desktop

The Remote Desktop application launches the TeamViewer Quick Support program, which is a simple, fast and secure remote control interface. You can use the application to receive ad-hoc remote support from Autel's support center, colleagues or friends, by allowing them to control your MaxiSys tablet on their PC via the TeamViewer software.

17.1 Operations

If you think of a TeamViewer connection as a phone call, the TeamViewer ID would be the phone number, under which all TeamViewer Clients can be reached separately. Computers and mobile devices that run TeamViewer are identified by a globally unique ID. The first time the Remote Desktop application is started, this ID is generated automatically based on the hardware characteristics and will not change.

Make sure the tablet is connected to the Internet before launching the Remote Desktop application, so that the tablet is able to receive remote support from the third party.

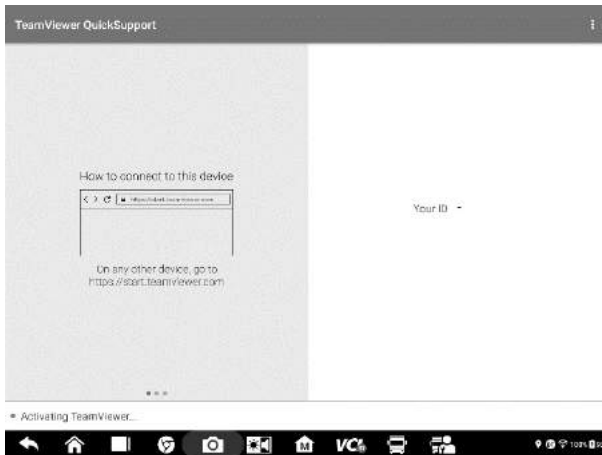

Figure 17-1 Remote Desktop Screen

➤ **To receive remote support from a partner**

1. Power on the tablet.
2. Tap the **Remote Desktop** application on the MaxiSys Job Menu. The TeamViewer interface displays and the device ID is generated and shown.
3. Your partner must install the Remote Control software to the computer by downloading the TeamViewer full version program online

(<http://www.teamviewer.com>). Start the software on the computer at the same time in order to provide support and take control of the tablet remotely.

4. Provide your ID to the partner, and wait for him/her to send you a remote control request.
5. A message displays to ask for your confirmation to allow remote control on your device.
6. Tap **Allow** to accept, or tap **Deny** to reject.

18 User Feedback

The User Feedback feature allows you to submit questions related to this product.

The image shows a mobile application screen titled "User feedback". At the top left is a back arrow icon, and at the top right is a user profile icon. The form contains several input fields: "Serial number" (with a blurred value), "Telephone/Email" (with a blurred value), "Feedback type" (with radio buttons for "Hardware Problem", "Software Problem", "Optimization Suggestion", and "Other"), "Theme" (with a dropdown menu), and "Problem description" (with a blurred value). Below these fields are five icons for attaching media: "Recording" (microphone), "Album" (photo album), "Photo" (camera), "Doc" (plus sign), and "Local file" (document). Underneath these icons is a "Files" section showing a list of files. At the bottom right of the form is a "Submit" button. The bottom of the screen shows a standard Android navigation bar with icons for back, home, recent apps, camera, gallery, mail, VCL, printer, and a notification area on the right.

Figure 18-1 Sample User Feedback Screen

➤ **To send new user feedback**

1. Register the product online, see [Product Registration](#) for detailed information.
2. Tap **User Feedback** on the MaxiSys Job Menu. The device information is automatically synchronized with the online account.
3. Enter your telephone number/email address, feedback type, theme, and problem description. You can also attach a voice recording, photo, photo album, screen captures, image or PDF files with the form. To help resolve the issue efficiently, we recommend you to complete the form with as much detailed as possible.
4. Tap **Submit** to send the completed form to Autel's online service center. The submitted feedback will be carefully read and handled by our service personnel.

19 Maintenance and Service

To ensure that the tablet, the combined VCI unit, and the B200 perform at their optimum level, we advise that the product maintenance instructions in this section are strictly followed.

19.1 Maintenance Instructions

The following includes how to maintain your devices, together with precautions to take.

- Use a soft cloth dampened with alcohol or mild glass cleaner to clean the tablet touchscreen at the end of each work day.
- Do not use any abrasive cleansers, detergent or automotive chemicals on the tablet.
- Keep the devices in dry conditions and within specified operating temperatures.
- Dry your hands before using the tablet. The touchscreen of the tablet may not work when it is moist, or when you tap the touchscreen with wet hands.
- Do not store the devices in humid, dusty or dirty areas.
- Check the housing, wiring, and connectors for dirt and damage before and after each use.
- Do not attempt to disassemble your tablet, the VCI unit or the B200.
- Do not drop or cause severe impact to the devices.
- Use only authorized battery chargers and accessories. Any malfunction or damage caused by the use of unauthorized battery charger or accessories will void the limited product warranty.
- Ensure that the battery charger does not contact conductive objects.
- Do not use the tablet beside microwave ovens, cordless phones and certain medical or scientific instruments to prevent signal interference.

19.2 Troubleshooting Checklist

A. When the tablet does not work properly:

- Make sure the tablet has been registered online.
- Make sure the system software and diagnostic application are properly updated.
- Make sure the tablet is connected to the Internet.
- Check all cables, connections, and indicators to see if the signal is being received.

B. When battery life is shorter than usual:

- This may happen when you are in an area with low signal strength. Turn off your device if it is not in use.

C. When you cannot turn on the tablet:

- Make sure the tablet is connected to a power source or the battery is fully charged.

D. When you are unable to charge the tablet:

- Your charger maybe out of order. Contact your nearest dealer.
- You may be attempting to use the device in an overly hot/cold temperature. Charge the device in a temperate area.
- Your device may not be connected to the charger properly. Check the connector.

 **NOTE**

If the problems persist, please contact Autel's technical support personnel or your local selling agent.

19.3 About Battery Usage

Your tablet is powered by a built-in lithium-ion polymer battery, which enables you to recharge your battery when there is electricity left.

 **DANGER**

The built-in lithium-ion polymer battery is factory-replaceable only. Incorrect replacement or tampering with the battery pack may cause an explosion.

- Do not use a damaged battery charger.
- Do not disassemble, open, crush, bend, deform, puncture, or shred the battery.
- Do not modify, remanufacture or attempt to insert foreign objects into the battery, or expose the battery to fire, explosion, or other hazards.
- Only use the specified charger and USB cables. Use of non-Autel-authorized charger or USB cables may lead to device malfunction or failure.
- Use of an unqualified battery or charger may present a risk of fire, explosion, leakage, or other hazards.
- Avoid dropping the tablet. If the tablet is dropped, especially on a hard surface, and you suspect damage, take the tablet to a service center for inspection.
- Try to keep closer to your wireless router to reduce battery usage.
- The time needed to recharge the battery varies depending on the remaining battery capacity.
- Battery life inevitably shortens over time.
- Unplug the charger once the tablet is fully charged since overcharging may shorten battery life.
- Keep the battery in temperate environments. Do not place it inside a car when it is too hot or too cold, which may reduce the capacity and life of the battery.

19.4 Service Procedures

This section provides information on technical support, repair service, and application for replacement or optional parts.

19.4.1 Technical Support

If you have any question or problem on product operations, please contact us.

AUTEL NORTH AMERICA

- **Phone:** 1-855-AUTEL-US (288-3587) (Monday-Friday, 9AM-9PM Eastern Time)
- **Website:** www.autel.com
- **Email:** ussupport@autel.com; sales@autel.com; careers@autel.com
- **Address:** 175 Central Avenue, Suite 200, Farmingdale, New York, USA 11735

AUTEL EUROPE

- **Phone:** 0049 (0) 6103-2000520 (Monday-Friday, 9:00AM-6:00PM Berlin Time)
- **Website:** www.autel.eu
- **Email:** sales.eu@autel.com; support.eu@autel.com
- **Address:** Adalperostraße 82, 85737 Ismaning, Germany

AUTEL CHINA HQ

- **Phone:** 0086-755-2267-2493 (Monday-Friday, 9:00AM-6:00PM Beijing Time)
- **Website:** www.autel.com
- **Email:** support@autel.com; sales@auteltech.net
- **Address:** 7-8th, 10th Floor, Building B1, Zhiyuan, Xueyuan Road, Xili, Nanshan, Shenzhen, 518055, China

AUTEL LATIN AMERICA

- **Website:** www.autel.com
- **Email:** sales.latin@autel.com; latsupport02@autel.com
- **Address:** Avenida Americas 1905, 6B, Colonia Aldrete, Guadalajara, Jalisco, Mexico

AUTEL APAC

- **Phone:** +045 5948465
- **Website:** www.autel.com/jp/
- **Email:** sales.jp@autel.com; support.jp@autel.com
- **Address:** 719, Nissou Building, 3-7-18, Shinyokohama, Kouhoku, Yokohama, Kanagawa, Japan 222-0033

AUTEL IMEA DMCC

- **Phone:** +971 585 002709
- **Website:** www.autel.com
- **Email:** sales.imea@autel.com; imea-support@autel.com
- **Address:** Office 1006-1010, Cluster C, Fortune Tower, Jumeirah Lakes Tower (JLT), Dubai, U.A.E

For technical assistance in other markets, please contact your local selling agent.

19.4.2 Repair Service

If it is necessary to send back your device for repair, please download and fill out the repair service form from www.autel.com. The following information must be included:

- Contact name
- Return address
- Telephone number
- Product name
- Complete description of the problem
- Proof-of-purchase for warranty repairs
- Preferred method of payment for non-warranty repairs

NOTE

For non-warranty repairs, payment can be made with Visa, Master Card, or with approved credit terms.

Send the device to your local agent, or to the address below:

7-8th, 10th Floor, Building B1, Zhiyuan,
Xueyuan Road, Xili, Nanshan,
Shenzhen, 518055, China

19.4.3 Other Services

You can purchase the accessories directly from authorized tool suppliers of Autel, or your local distributor or agent.

Your purchase order should include the following information:

- Contact information
- Product or part name
- Item description
- Purchase quantity

20 Compliance Information

FCC Compliance

FCC ID: WQ8MAXISYSMS909CV

This equipment has been tested and verified to comply with the limits for a Class B digital device, pursuant to Part 15 of the FCC Rules. These limits are designed to provide reasonable protection against harmful interference in a residential installation. This equipment generates uses and can radiate radio frequency energy and, if not installed and used in accordance with the instructions, may cause harmful interference to radio communications. However, there is no guarantee that interference will not occur in a particular installation. If this equipment does cause harmful interference to radio or television reception, which can be determined by turning the equipment off and on, the user is encouraged to correct the interference by one or more of the following measures:

- Reorient or relocate the receiving antenna.
- Increase the separation between the equipment and receiver.
- Consult the dealer or an experienced radio/TV technician for help.

This device complies with part 15 of the FCC Rules. Operation is subject to the following two conditions:

- (1) This device may not cause harmful interference, and
- (2) This device must accept any interference received, including interference that may cause undesired operation.

Changes or modifications not expressly approved by the party responsible for compliance could void the user's authority to operate the equipment.

SAR:

The radiated output power of this device is below the FCC radio frequency exposure limits. Nevertheless, the device should be used in such a manner that the potential for human contact is minimized during normal operation.

The exposure standard for wireless devices employs a unit of measurement known as the Specific Absorption Rate, or SAR. The SAR limit set by the FCC is 1.6 W/Kg. Tests for SAR are conducted using standard operating positions accepted by the FCC with the device transmitting at its highest certified power level in all tested frequency bands. Although the SAR is determined at the highest certified power level, the actual SAR level of the device while operating can be well below the maximum value. This is because the device is designed to operate at multiple power levels to use only the power required to reach the network. To avoid the possibility of exceeding the FCC radio frequency exposure limits, human proximity to antenna should be minimized.

21 Warranty

21.1 12-Month Limited Warranty

Autel Intelligent Technology Corp., Ltd. (the Company) warrants to the original retail purchaser of this MaxiSys Diagnostic Device that should this product or any part thereof during normal usage and under normal conditions be proven defective in material or workmanship that results in product failure within twelve (12) months period from the date of purchase, such defect(s) will be repaired, or replaced (with new or rebuilt parts) with Proof of Purchase, at the Company's option, without charge for parts or labor directly related to the defect(s).

The Company shall not be liable for any incidental or consequential damages arising from the use, misuse, or mounting of the device. Some states do not allow limitation on how long an implied warranty lasts, so the above limitations may not apply to you.

This warranty does not apply to:

- a) Products subjected to abnormal use or conditions, accident, mishandling, neglect, unauthorized alteration, misuse, improper installation or repair or improper storage;
- b) Products whose mechanical serial number or electronic serial number has been removed, altered or defaced;
- c) Damage from exposure to excessive temperatures or extreme environmental conditions;
- d) Damage resulting from connection to, or use of any accessory or other product not approved or authorized by the Company;
- e) Defects in appearance, cosmetic, decorative or structural items such as framing and non-operative parts.
- f) Products damaged from external causes such as fire, dirt, sand, battery leakage, blown fuse, theft or improper usage of any electrical source.

! IMPORTANT

All contents of the product may be deleted during the process of repair. You should create a back-up copy of any contents of your product before delivering the product for warranty service.
