

Alpha Automatic Key Cutting Machine

Product Catalog

Inherit spirit of locksmith, concentrate on automatic key cutting machine



Official Website: www.kkkcut.com



Hunan Kukai Electromechanical Co., Ltd
www.kkkcut.com

Make sure to comply with the followings when using Alpha:

- 1 The equipment is designed to be operated under DC24V. Normal operations are only made when DC24V is supplied. When the supplied power is over than DC24V, the equipment may not be operated accurately. In particular, under low voltage(less than 24V), DC motor output decreases, which leads to lower speed of rotation.
- 2 Please replace cutter on a regular basis. Delayed replacement may deteriorate the cutting force, which leads to failure of accurate cutting.
- 3 The cutting effect of the cutter depends on the material of the key blank. Select preferable speed and cutting times to cut hard key blank.
- 4 Take cautions not to drop the machine and keep the machine away from wet.
- 5 Make sure to enter correct key data and input correct key biting number.
- 6 Keep the car engine on while using the machine connected to the cigar jack.

Product Catalog



Cautions	01
Standard Package	03
Parts Name	05
Power Adapter	07
Specification	08
Consumable Items	09
Cutter	09
Decoder	10
Key Fixation	11
Jaw Instruction	15
S1-S4 Jaw	15
Standard Menu	16
Jaw Calibration	19
S1-S4 Jaw	19
Search	27
Key Blank Search	27
ID Search	28
Settings Menu	29
Language	29
Software Upgrade	30
Settings	31
Machine Info	33

Key Decoding	34
Key Cutting	35
Cutting Depth Adjustment	37
Layered Cutting	39
Jaw Movement	41
Code	43
Progression	45
Duplicate	47
Single Standard Key	47
Double Standard Key	48
Single External Groove Key	49
Double External Groove Key	50
Internal Groove	51
Tubular Key	52
Custom Keys	53
Double Standard Key	53
Single Internal Groove Key	55
Double Internal Groove Key	57
Dimple Key	59
Single Standard Key	61
Single External Groove Key	63
Double External Groove Key	65
Tubular Key	67
Favorites	69
Cut History	69
Wifi Connection	70
Software Activation	71
Warranty	72

Cautions

Alpha Automatic Key Cutting Machine

Alpha Automatic Key Cutting Machine

Cautions

Safety Instructions

- Make sure to observe the followings for using the equipment safely;
 - It indicates that you may get injured or damage the equipment if fail to follow the instructions.
- Below information is provided to enhance the user security awareness and prevent property loss. Read the cautions carefully for correct use.
 - It indicates that you can be seriously injured if fail to follow the instructions

Cautions for Power

	Never use damaged power cords or loose plugs or sockets.		Never plug in many power cords in one outlet simultaneously, otherwise the outlet may get too hot and cause fire.
	Never pull out the plug by tugging the power cord, or touch the metal part of the power plug.		Keep the equipment unplugged when unused for a long time.
	If smoke rises up or abnormal voice sounds when using the equipment, turn off the power right away and contact your dealer or our factory for advice.		Cigar jack fuse may blow out if you connect the equipment with the vehicle cigar jack. In such a case, use a new fuse in 10A or more. You can only connect the equipment with cigar jack while the vehicle engine is running.

Cautions for Installation

	Do not install the equipment in a place with oil, smog, moist, dust and water splashing, it may cause electric shock or fire.		Do not put burning cigarettes or candles on the equipment; keep the equipment away from heating devices like stoves when installation, otherwise it may get overheated, resulting in equipment failure or cause fire.
	Make sure to install the equipment on stable flat surface. The equipment weights about 16kg and generates vibration during operation. if you use the equipment on bumpy surface, it may lead to damages on equipment/worktable and injuries on users.		

Caution for Usage

	The cutter of the equipment spins at high speed during operation. Keep your body or clothing or other things away from the equipment, otherwise the user may get seriously injured by the cutter.		Do not put any tools, water containers, mugs, cups or small metal pieces on the equipment or crumb tray.
			Vibration of the equipment and carelessness of the user may cause falling of the above objects, which leads to injuries on the user.
			Overheating or electric leakage may lead to fire or equipment failure. It may cause electric shock or fire when the equipment gets wet.

Other cautions

	Do not disassemble or modify the equipment. It may cause fire, electric shock and equipment failure. If you need a check-up, adjustment, repair of the equipment, please ask your dealer or contact our factory for advice.		Keep children away from the equipment, their curiosity or carelessness may lead them to be injured.
	In winter (sub-zero temperatures), the equipment may be unable to work properly. In such a case, the user can increase temperature of working environment. Do not let the temperature of working environment goes lower than zero.		

Standard Package

Alpha Automatic Key Cutting Machine

Name	Picture	Quantity	Purpose
Alpha Automatic Key Cutting Machine		1EA	Duplicating and cutting keys
S1 Jaw (4-Way Jaw)		1EA	Fixing standard keys, laser keys and dimple keys. (Dimple cutter and decoder is optional)
Cutter		2EA	Key cutting tool
Decoder		2EA	Key decoding tool
Calibration Block		1EA	Calibrating jaw
Stopper		1EA	Guiding key reference position
M3 Bolt		2EA	Fixing keys on Side C/D of S1 jaw

Alpha Automatic Key Cutting Machine

Standard Package

Name	Picture	Quantity	Purpose
M5 Bolt		2EA	Fixing cutter and decoder
1.5mm L-wrench		1EA	Tightening M3 bolts
2.5mm T-wrench		1EA	Tightening M5 bolts
24V Adaptor with Power Cord		1EA	Power supply INPUT 100~240V 50/60 Hz 2A OUTPUT 24V 5A
Brush		1EA	
Product Manual		1EA	

1 Tips: Cutter and decoder are consumable items. Make sure to replace it after a certain period of use.

Parts Name

Alpha Automatic Key Cutting Machine

Alpha Automatic Key Cutting Machine

Parts Name



1 Attention

- Strike, heavy and sharp things may damage the display screen.
- Decoder is consumable item, easy to damage.
- Don't throw or strike decoder casually.
- Kukai is not responsible for decoder damaged in any cases.

Accessories/Components for Power

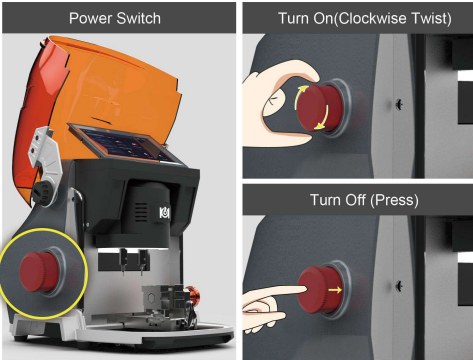

Connect the power adaptor, clockwise twist switch to turn on the equipment, press switch to turn off the equipment.

Equipment Specification

Power Input	
Voltage	DC24V/5A
Power	120W
Dimension	305(W) x 300(H) x 400(D)mm
Weight	16kg
Accuracy	XY Axis:0.0025mm Z Axis:0.0025mm
Spindle Speed	12000+rpm
Working Temperature Range	0-40°C
Working Humidity Range	10-90%
Usage	To cut automobile keys, residential keys, motorcycle keys, dimple keys, tubular keys, FO21 tibbe keys.

Cutter

- 1.1 Installation
- 1.2 Disassembly

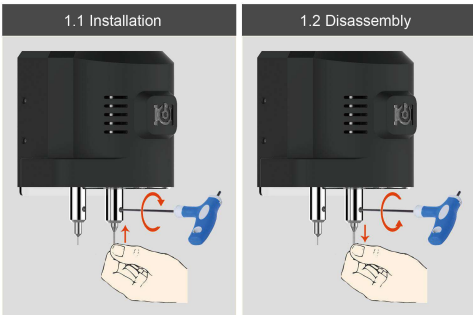

Steps for Cutter Installation

- (1) Insert the cutter into the cutter holder and push it to the limit
- (2) Fix M5 screw tightly by turning 2.5mm T-wrench clockwise

Steps for Cutter Disassembly:

- (1) Hold the cutter and loosen M5 screw by turning 2.5mm T-wrench counterclockwise.
- (2) Take the cutter out after it looses.

Decoder

- 2.1 Installation
- 2.2 Disassembly

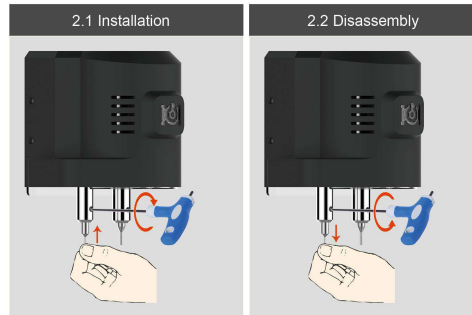

Steps for Decoder Installation:

- (1) Insert the decoder into the cutter holder and push it to the limit
- (2) Fix M5 screw tightly by turning 2.5mm T-wrench clockwise

Steps for Decoder Disassembly:

- (1) Hold the decoder and loosen M5 screw by turning 2.5mm T-wrench counterclockwise.
- (2) Take the decoder out after it looses.

Standard Key Fix the key at Side C&D with stopper.

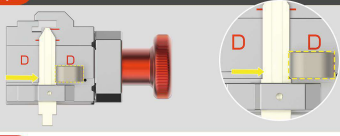

Laser Key Fix the key at Side A&B, no need to use stopper.

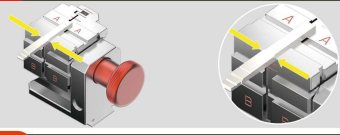

Standard Key Fix the key at Side C&D, no need to use stopper.

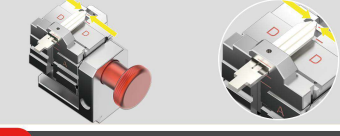

Laser Key Fix the key at Side A&B, no need to use stopper.

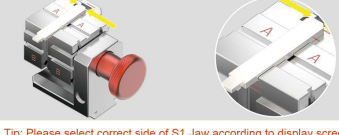

Shoulder Align

Tip Align

Tip: Please select correct side of S1 Jaw according to display screen shown.

Please avoid below mistakes when fixing the keys

S1 Jaw - Standard Key

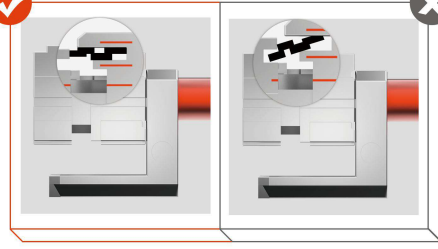

S1 Jaw - Laser Key

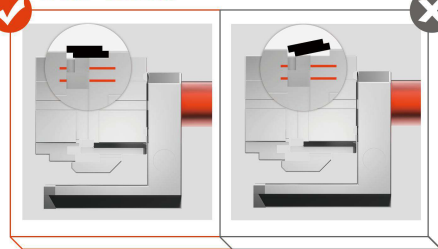

Please avoid below mistakes when fixing the keys

Please avoid below mistakes when fixing the keys

S2 Jaw - Single Standard Key

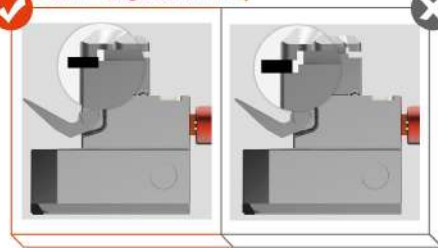

S3 Jaw - Tubular Key

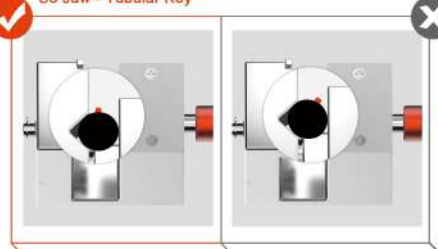



S4 Jaw - Available for Ford/Jaguar FO21 Tibbe keys



Jaw Instruction













Alpha Automatic Key Cutting Machine

	
<p>Available for Double standard keys, Single internal groove keys, Single external groove keys, Double internal groove keys, Double external groove keys, Dimple keys</p>	<p>Available for Single standard keys</p>
	
<p>Available for Tubular keys</p>	<p>Available for Ford FO21 Tibbe (8cuts) and Jaguar FO21 Tibbe (8cuts) keys</p>

Alpha Automatic Key Cutting Machine

Standard Menu







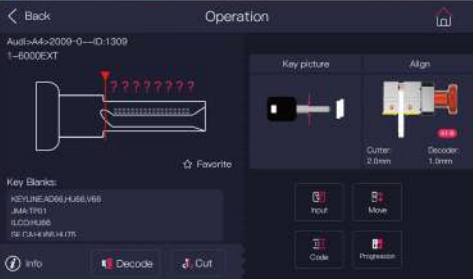

	Automobile	<input type="text" value="C Search"/>	Search
	Motorcycle		Jaw Calibration
	Single Standard		Cut History
	Tubular		Duplicate
	Dimple		Custom Keys
	Menu		Favorites
	Message		

Standard Menu

Alpha Automatic Key Cutting Machine



	Collect common keys		Input biting numbers
	Show basic information		Move jaw
	Decode key		Get biting numbers by key code
	Cut key		Input existing biting numbers to get unknown biting number

Alpha Automatic Key Cutting Machine

Standard Menu



	Please insert the cutter shown as picture.
<input type="text" value="2.0mm"/>	You can adjust the cutter dimension within the range of 2.5mm, based on the actually used cutter.
	You can manually set the cutting depth when cutting laser keys.
<input type="text" value="1.15mm"/>	Cutting depth
	Layered Cutting
When cutting laser keys, you can choose 1, 2 or 3 times to finish the cutting depth. The harder the key blank is, the more times will be needed.	
	Cancel the operation
	Start to cut key

1. Automobile Key Jaw (S1-A)

Step 1



Choose Automobile Key Jaw (S1)

Step 2



Choose Side A (S1-A)

Change cutter to decoder, place the calibration block and fix Jaw tightly , then click "OK" button shown as picture



Step 3

2. Automobile Key Jaw (S1-B)

Step 1



Choose Automobile Key Jaw (S1)

Step 2



Choose Side B (S1-B)

Change cutter to decoder, place the calibration block and fix Jaw tightly , then click "OK" button shown as picture



Step 3

3. Automobile Key Jaw (S1-C)

Step 1



Choose Automobile Key Jaw (S1)

Step 2



Choose Side C (S1-C)

Change cutter to decoder, place the calibration block and fix Jaw tightly , then click "OK" button shown as picture



Step 3

4. Automobile Key Jaw (S1-D)

Step 1



Choose Automobile Key Jaw (S1)

Step 2



Choose Side D (S1-D)

Change cutter to decoder, place the calibration block and fix Jaw tightly , then click "OK" button shown as picture



Step 3

5. Single Standard Key Jaw (S2-A)

Step 1

Choose Single Standard Key Jaw (S2)



Step 2

Choose Side A (S2-A)



Change cutter to decoder and fix Jaw tightly, then click "OK" button shown as picture

Step 3



6. Single Standard Key Jaw (S2-B)

Step 1

Choose Single Standard Key Jaw (S2)



Step 2

Choose Side B (S2-B)



Change cutter to decoder and fix Jaw tightly, then click "OK" button shown as picture

Step 3



7. Tubular Key Jaw (S3)

Step 1

Choose Tubular Key Jaw (S3)



Step 2

Choose Jaw S3



Change cutter to decoder and fix Jaw tightly, then click "OK" button shown as picture

Step 3



8. Ford/Jaguar Tibbe Key Jaw (S4)

Choose Tibbe Key Jaw (S4)

Step 1



Step 2

Choose Jaw S4



Change cutter to decoder and fix Jaw tightly, then click "OK" button shown as picture

Step 3



Example:HU66 (Volkswagen,Audi,Skoda)
 You can search key data by key blank

(However you have to be familiar with car key for using this function)

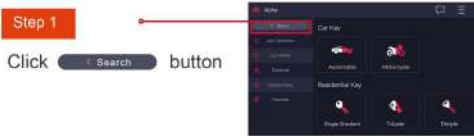

Example:909 (Volkswagen,Audi,Skoda)
 You can search key data by ID

(However you have to be familiar with ID from Instacode for using this function)

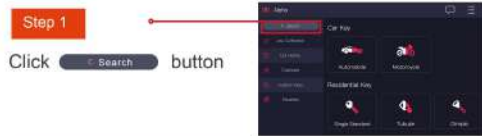

Language

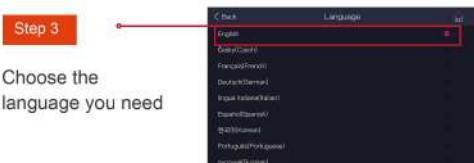

Software Upgrade



Settings-Cutting Speed

Step 1
Click  button



Step 2
Click "Settings" button



Step 3
Click "Cutting Speed" button



Step 4
Slide progress bar to adjust cutting speed



Settings-Others

Step 1
Click  button



Step 2
Click "Settings" button



Step 3
Click "Others" button



Step 4
Select to open shield when cutting keys or not

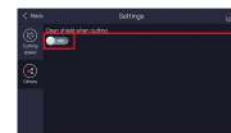

Machine Info

Step 1
Click  button



Step 2
Click "Machine Info" button



Step 3
View details of "Machine Info"



Key Decoding

Step 1
Click  button



Step 2

1. Confirm key's position
2. Place the decoder shown as picture
3. Click "Decode" button



Step 3
Decoding, wait a moment



Step 4
Decoding is done



Example: Audi-Q7-2006~0--ID:909
(Input known biting numbers to cut a key when the original key is lost)

Step 1 Click  button in Home Page



Step 2 Choose "Audi" in the list

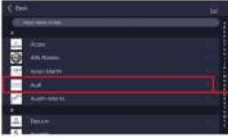

Step 3 Choose "Q7" in the list

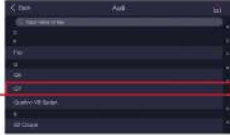

Step 4 Choose the year of manufacturing





Example: Audi-Q7-2006~0--ID:909
(Input known biting numbers to cut a key when the original key is lost)

Click  button



Step 5 Input known biting numbers then click "OK" button



Step 6 Check if the biting numbers are correct or not, then click  button



Step 7

1. Fix the key shown as picture
2. Insert cutter at the right side
3. Click  button to cut key after confirmed



Step 8

Example : Honda Accord-2003~2006--ID: 982

Step 1 Click  button in Home Page



Step 2 Choose "Honda" in the list

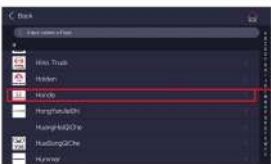

Step 3 Choose "Accord" in the list

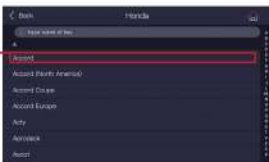

Example : Honda Accord-2003~2006--ID: 982

Choose the year of manufacturing



Step 4 Click  button to pop out invisible window



Step 5 Change the cutting depth by "+, -" button



Step 6

Example: Audi-Q7-2006~0--ID:909
(Input known biting numbers to cut a key when the original key is lost)

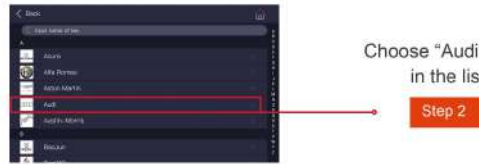

Example: Audi-Q7-2006~0--ID:909
(Input known biting numbers to cut a key when the original key is lost)



Example: Audi-Q7-2006~0--ID:909
(Input known biting numbers to cut a key when the original key is lost)



Example: Audi-Q7-2006~0--ID:909
(Input known biting numbers to cut a key when the original key is lost)

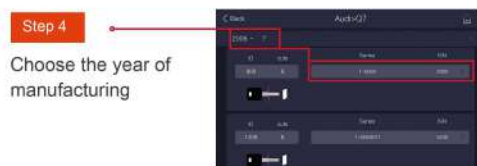

Example : Honda Accord-2003~2006--ID: 982
(How to cut a key when original key is lost)

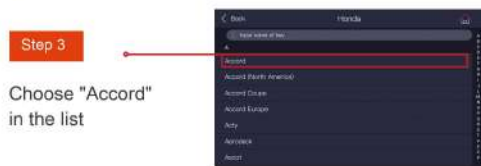
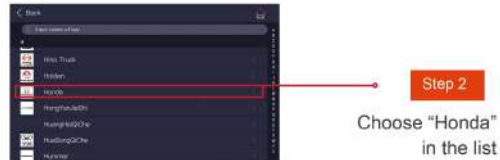

43 page

Example : Honda Accord-2003~2006--ID: 982
(How to cut a key when original key is lost)

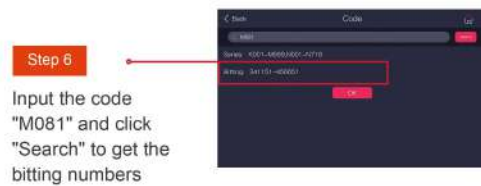

44 page

Example: Audi-Q7-2006~0--ID:909

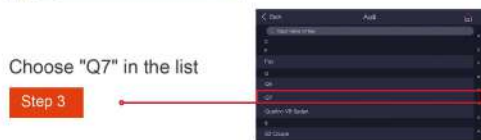
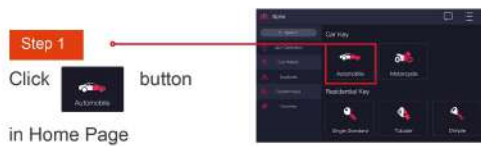

45 page

Example: Audi-Q7-2006~0--ID:909

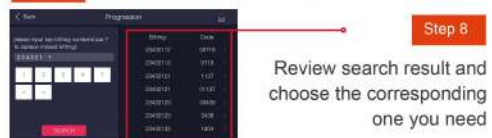
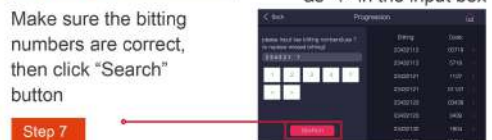
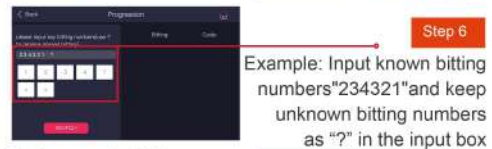

46 page

Single Standard Key



Step 1

Step 2

Click "Duplicate" button in Home Page

Click "Single Standard" button



Step 3

Step 4

Click "Shoulder" button

Click "Jaw S2-A" button



Step 5

Click "Cut" button after duplicating is done

Double Standard Key



Step 1

Step 2

Click "Duplicate" button in Home Page

Click "Double Standard" button



Step 3

Step 4

Click "Shoulder" button

Click "Jaw S1-D" button



Step 5

Click "Cut" button after duplicating is done

Single External Groove Key



Step 1

Step 2

Click "Duplicate" button in Home Page

Click "Single External Groove" button



Step 3

Step 4

Click "Up Single Track Shoulder" button

Click "Jaw S1-B" and adjust cutter diameter value



Step 5

Click "Cut" button after duplicating is done

Double External Groove key



Step 1

Step 2

Click "Duplicate" button in Home Page

Click "Double External Groove" button



Step 3

Step 4

Click "Shoulder" button

Click "Jaw S1-B" and adjust cutter diameter value



Step 5

Click "Cut" button after duplicating is done

Internal Groove Key



Step 1

Click "Duplicate" button in Home Page



Step 2

Click "Internal Groove" button



Step 3

Click "Shoulder" button



Step 4

Click "Jaw S1-B" and adjust cutter diameter value



Step 5

Click "Cut" button after duplicating is done

Tubular Key



Step 1

Click "Duplicate" button in Home Page



Step 2

Click "Tubular" button



Step 3

Click "Jaw S3" button



Step 4

Click "Cut" button after duplicating is done

1. Tips: 1.All above about "Duplicate" is just examples showing you how to do, please select correctly according to the key you actually have.
2.The default cutter diameter value is 2.0mm in Alpha. If you don't use 2.0mm cutter, please adjust it within the range of 2.5mm, based on the actually used cutter.

Double Standard Key



Step 1

Click "Custom Keys" button in Home Page



Step 2

Click "Add New Key" button



Step 3

Click "Double Standard" and "Next" button



Step 4

Click "Shoulder" and "Next" button



Step 5

Input the parameters in space location and click "Next" button



Step 6

Input the parameters in space width and click "Next" button



Step 7

Input the parameters in depth and click "Next" button



Step 8

Input the parameters in width and click "Next" button



Step 9

Choose correct "Jaw S1-D" and click "Next" button



Step 10

Name the new key data and click "OK" button



Step 11

Review the key data you just added

Single Internal Groove Key



Step 1
Click "Custom Keys" button in Home Page



Step 2
Click "Add New Key" button



Step 3
Click "Single Internal Groove Key" and "Next" button



Step 4
Click "Shoulder" and "Next" button



Step 5
Choose Side "A" and input the parameters in space location and click "Next" button



Step 6
Input the parameters in space width and click "Next" button



Step 7
Input the parameters in depth and click "Next" button



Step 8
Input the parameters in width, thickness, cut depth, groove and guide, and click "Next" button



Step 9
Choose correct "Jaw S1-B" and click "Next" button



Step 10
Name the new key data and click "OK" button



Step 11
Review the key data you just added

Double Internal Groove Key



Step 1
Click "Custom Keys" button in Home Page



Step 2
Click "Add New Key" button



Step 3
Click "Double Internal Groove" and "Next" button



Step 4
Click "Shoulder" and "Next" button



Step 5
Input the parameters in space location and click "Next" button



Step 6
Input the parameters in space width and click "Next" button



Step 7
Input the parameters in depth and click "Next" button



Step 8
Input the parameters in width, thickness, cut depth and nose, and click "Next" button



Step 9
Choose correct "Jaw S1-B" and click "Next" button



Step 10
Name the new key data and click "OK" button



Step 11
Review the key data you just added

Dimple Key

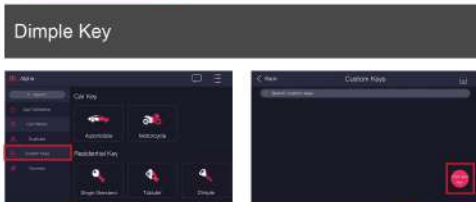

Step 1
Click "Custom Keys" button in Home Page



Step 2
Click "Add New Key" button



Step 3
Click "Dimple" and "Next" button



Step 4
Click "Shoulder" and "Next" button



Step 5
Input the parameters in space location and click "Next" button



Step 6
Input the parameters in depth and click "Next" button



Step 7
Input the parameters in width & thickness and click "Next" button

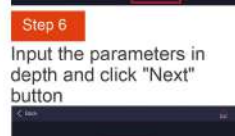

Step 8
Choose correct "Jaw S1-B" and click "Next" button



Step 9
Name the new key data and click "OK" button



Step 10
Review the key data you just added.

Single Standard Key

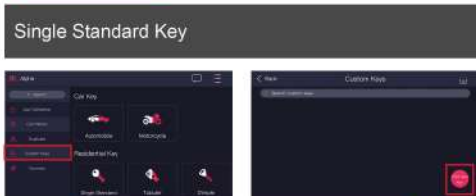

Step 1
Click "Custom Keys" button in Home Page



Step 2
Click "Add New Key" button



Step 3
Click "Single Standard" and "Next" button



Step 4
Click "Shoulder" and "Next" button



Step 5
Input the parameters in space location and click "Next" button



Step 6
Input the parameters in space width and click "Next" button



Step 7
Input the parameters in depth and click "Next" button

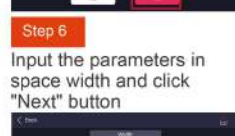

Step 8
Input the parameters in width and click "Next" button



Step 9
Name the new key data and click "OK" button



Step 10
Review the key data you just added.

Single External Groove Key



Step 1

Click "Custom Keys" button in Home Page



Step 2

Click "Add New Key" button



Step 3

Click "Single External Groove" and "Next" button



Step 4

Click "Shoulder" and "Next" button



Step 5

Choose Side "A" and input the parameters in space location and click "Next" button



Step 6

Input the parameters in space width and click "Next" button



Step 7

Input the parameters in depth and click "Next" button



Step 8

Input the parameters in width, thickness, cut depth, guide and nose, and click "Next" button



Step 9

Choose correct "Jaw S1-B" and click "Next" button



Step 10

Name the new key data and click "OK" button



Step 11

Review the key data you just added.

Double External Groove Key

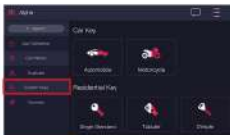

Step 1

Click "Custom Keys" button in Home Page



Step 2

Click "Add New Key" button



Step 3

Click "Double External Groove" and "Next" button



Step 4

Click "Shoulder" and "Next" button



Step 5

Input the parameters in space location and click "Next" button



Step 6

Input the parameters in space width and click "Next" button



Step 7

Input the parameters in depth and click "Next" button



Step 8

Input the parameters in width, thickness, and cut depth, and click "Next" button



Step 9

Choose correct "Jaw S1-B" and click "Next" button



Step 10

Name the new key data and click "OK" button

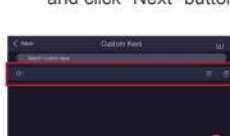

Step 11

Review the key data you just added.

Tubular Key



Step 1

Click "Custom Keys" button in Home Page



Step 2

Click "Add New Key" button



Step 3

Click "Tubular" and "Next" button



Step 4

Input the parameters in space location and click "Next" button



Step 5

Input the parameters in depth and click "Next" button



Step 6

Input the parameters in width,thickness, and cut depth, and click "Next" button



Step 7

Name the new key data and click "OK" button



Step 8

Review the key data you just added.

1 Tips: All above about "Custom Keys" is just examples showing you how to do , please select correctly according to the key drawing you actually have.

Favorites



You can check what keys you saved before.

Cut History



You can check the keys you cut before.

WIFI Connection

Step 1

Click "Set up" button in Desktop



Step 2

Click "WLAN" button

Choose the available WIFI in the list

Step 3



Step 4

Input password and click "Connect" button

Software Activation

Step 1

Open the software and log in Serial Number, Registration Code



Step 2

Find the label on the back cover of the equipment, where your serial number and registration code is.

Click "OK" button and complete the software activation

Step 3



Customer Information			
Product Model		Purchased Date	
Customer name		Company Name	
Telephone		Address	
Address			
Dealer Name		Company Name	
Telephone		Address	
Invalid if tear up			

▲ In principle, please contact dealer or manufacturer timely for the defective product

Product Name: Key Cutting Machine Product Model: Alpha

The machine warranty is 24 months from the purchased date from manufacturer. Below is the details:

1. Warranty Product: Alpha Key Cutting Machine (except consumables and accessories)

2. Warranty: 24 months from the purchased date from manufacturer. If the purchase date can't be confirmed, warranty is 25 months from production date.

3. Some cases not free in warranty time:

(1) Malfunctions caused by wars or natural disasters (fire, salt damages, gas, rainstorms or floods);

(2) Normal abrasions for consumables;

(3) Malfunctions caused by power off or wrong connection;

(4) Malfunctions caused by external factors instead of machine itself;

(5) Malfunctions caused by others instead of maintenances or reassembling by engineers from our company;

(6) Malfunctions by improper operations from customers.

4. Free service

Except above cases, malfunctions caused by other reasons are eligible for free service within warranty.

5. With regard to other items not stated here, our company will abide by

[rules of compensations against damages for customers]